



# ZEUS<sup>®</sup>

## POLYMER EXTRUSIONS



### CATALOG 11

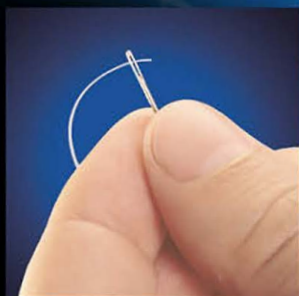
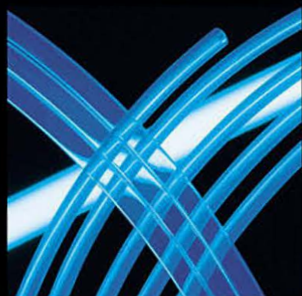

# CATALOG 11



WWW.ZEUSINC.COM

# Table of Contents

TABLE OF CONTENTS

<b>Applications . . . . .</b>	<b>3</b>	Special Shapes - Multi-Lumen . . . . .	43
Medical . . . . .	4	Performance Fiber . . . . .	44
Industrial. . . . .	5	Lay Flat Tubing™ . . . . .	45
<b>Extruded Sizes . . . . .</b>	<b>7</b>	Dual Tube™. . . . .	46
Extruded Tubing (AWG). . . . .	8	Splines - Wires, Cables, Coaxial Cores. . . . .	47
Heavy Construction Tubing. . . . .	12	Snaptube™ . . . . .	47
Heavy Wall Tubing . . . . .	13	Absorv™ . . . . .	48
Monofilament . . . . .	14	Aeos™ ePTFE Tubing and Monofilament . . . . .	49
Convuluted Tubing		<b>Value Added Services . . . . .</b>	<b>51</b>
PTFE. . . . .	15	Benefits of ZEUS Value Added Services	
FEP . . . . .	16	and Operations. . . . .	52
ETFE. . . . .	17	Bump/Draw-down . . . . .	52
Spiral-Cut Cable Wrap. . . . .	18	Custom-Cutting . . . . .	53
Extruded Metric Tubing		Custom Packaging & Labeling . . . . .	53
0.50mm Wall Tubing . . . . .	19	Drilling. . . . .	53
Extruded Metric Tubing		Etching. . . . .	53
1.00mm Wall Tubing . . . . .	20	Flaring and Flanging . . . . .	53
Extruded Metric Tubing		Heat Sealing . . . . .	54
1.50/2.00mm Wall Tubing. . . . .	21	Heat Shrinking over Mandrels. . . . .	54
<b>Heat Shrinkable Extrusions . . . . .</b>	<b>23</b>	Product Analysis & Enhancement . . . . .	54
ZEUS Heat Shrink Fluoropolymer Tubing. . . . .	24	Product Assembly - High Volume. . . . .	55
PTFE Heat Shrink 2 to 1 Shrink Ratio . . . . .	25	Product Assembly - Light. . . . .	55
PTFE Heat Shrink 4 to 1 Shrink Ratio . . . . .	29	Retractable Coil Tubing . . . . .	55
FEP Heat Shrink 1.3 to 1 Shrink Ratio. . . . .	30	Scoring. . . . .	56
FEP Heat Shrink 1.6 to 1 Shrink Ratio. . . . .	32	Slitting. . . . .	56
PTFE/FEP Dual-Shrink™ Tubing . . . . .	34	Striping . . . . .	56
<b>Specialty Products. . . . .</b>	<b>37</b>	Thermosetting/Forming . . . . .	56
PTFE Sub-Lite-Wall™		Tube Tipping . . . . .	56
Extruded & Heat Shrinkable Tubing . . . . .	38	PTFE Slitting and Cuffing . . . . .	57
PEEK Tubing . . . . .	40	<b>Technical Information . . . . .</b>	<b>59</b>
PEEKshrink™. . . . .	41	Resin Properties. . . . .	62
Peek Insulated Wire . . . . .	42	General Information . . . . .	71
		Technical Notes . . . . .	74





# ZEUS<sup>®</sup>

APPLICATIONS

## APPLICATIONS





WWW.ZEUSINC.COM

# Applications Medical

APPLICATIONS

As the leading supplier of fluoropolymer tubing in the medical device market, ZEUS is adapted to servicing a wide range of customer needs. We are experienced at working with all of the organizational elements of a medical device manufacturer. To assist these specialized requests we established a medical department within our sales force and staffed it with highly-trained and medical device oriented Technical Account Manager. ZEUS is a true pioneer of high performance plastics in this industry.

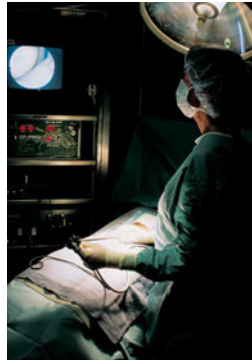

For the R&D engineer working on a new innovative product we offer quick turnaround, technical support, and free samples for prototyping. We work with production engineers to help improve yields and throughput. Regulatory specialists appreciate our quality systems and USP Class VI certified polymers. Purchasing



agents appreciate our stocking programs and the level of service and delivery we offer the industry. We offer a true cross functional relationship to our customers.

On the materials side, we offer a wide range of fluoropolymers and specialized plastics with a history of success in medical device applications. Many of our extruded, heat shrink, and multi-lumen tubes have been chosen for their pure, smooth, non-toxic, non-allergenic properties, as well as their compatibility with human tissues and fluids.

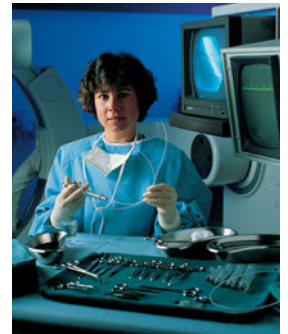

Most of what we manufacture for the medical device industry is extremely tight toleranced tubing. With our staff of skilled polymer experts and 45+ years of extrusion experience we are experts at customizing the properties of our polymers through process and material modification technologies.





WWW.ZEUSINC.COM

# Applications Industrial

APPLICATIONS

With more than 438,000+ sq ft. of manufacturing space ZEUS is ready to meet the challenges of the industrial markets. We have a strong working knowledge of a multitude of industries, including: automotive, chemical processing, electronic, aerospace and defense, fiber optics, environmental and analytical. We understand that new products and material enhancements are critical for our customers to remain competitive and successful. ZEUS offers a wide variety of standard and specialized products to meet your needs. ZEUS' knowledgeable Technical Account Managers are standing by to help you design the product you need.



## Fluid Handling

The demand for fluoropolymer tubing in fluid applications continues to increase as requirements become more specific. With ID from .002" up to 2.0", ZEUS' line of chemically resistant extrusions withstands corrosive fluids like sulfuric acid, hydrocarbon fuels and strong mineral acids.

High purity resins are used to extrude tubing with the lowest levels of extractables and the smoothest surface finish for use in semiconductor and pharmaceutical applications. FEP Lined Polyethylene tubing for environmental applications and PEEK™ tubing for analytical applications are a few of the specialty markets served. FEP, PFA and MFA tubing support applications ranging from laboratory plumbing, food processing and adhesive transfer systems to fuel, paint and hydraulic lines.



Increasing barrier properties creates tubing with the lowest water vapor transmission rates of any plastic. This is an example of the advances ZEUS has made to remain a leader in highly engineered extrusions. As new applications develop the need for our exceptional polymer product line increases significantly.





WWW.ZEUSINC.COM

# Applications Industrial

APPLICATIONS

## Electrical/Mechanical

ZEUS has the broadest product line of fluoropolymer tubing used for applications demanding unsurpassed



mechanical properties. The low friction, light weight and high temperature characteristics of fluoropolymer tubing are applied in applications where other plastics would fail. ZEUS tubing has met or exceeded the critical environments in



aviation programs worldwide. Some of these products include AWG tubing and heat shrinkable tubing for insulation, in addition to spiral cut cable wrap and

convoluted tubing for wire harnesses and cable assemblies.

A few examples of the wide array of electrical applications includes microware cable insulation featuring extrusions directly over wire, connector and terminal sleeves, fiber optic cable jacketing, hermetic motor insulation and battery pack and capacitor encapsulation.

Mechanical applications are not limited to the industry standard materials. Chemical modifiers are used

for enhanced push-pull cable jacketing, wafer thin bushings, watertight encapsulation, greaseless



bearings, tire valve seals and chafe guards. To extend the life of many components, ZEUS also supplies a wide range of heat shrinkable extrusions that have become an effective means of applying a tight jacketing that stands up to the hostile environments of heat, abrasion and shock.





# ZEUS<sup>®</sup>



**EXTRUDED  
SIZES**

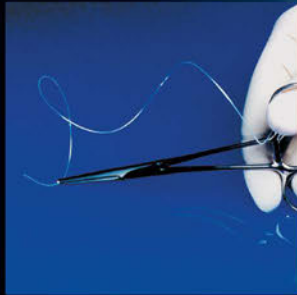

**EXTRUDED SIZES**

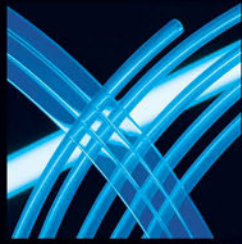

WWW.ZEUSINC.COM

# PTFE, FEP, PFA, ETFE

## Extruded Tubing

EXTRUDED SIZES



### Dimensions (Inches)

AWG Size	INSIDE DIAMETER			WALL DIMENSIONS					
	Min.	Nom.	Max.	Standard Wall Nom.	Standard Wall Tol.	Thin Wall Nom.	Thin Wall Tol.	Lightweight Wall Nom.	Lightweight Wall Tol.
*32	0.008	0.010	0.012	0.005	±.002	0.005	±.002	-	-
30	0.010	0.012	0.015	0.009	±.002	0.009	±.002	0.006	±.002
28	0.013	0.015	0.018	0.009	±.002	0.009	±.002	0.006	±.002
26	0.016	0.018	0.021	0.009	±.002	0.009	±.002	0.006	±.002
24	0.020	0.022	0.026	0.012	±.002	0.010	±.003	0.006	±.002
*23	0.023	0.026	0.029	0.012	±.002	0.010	±.003	0.006	±.002
22	0.025	0.028	0.032	0.012	±.002	0.010	±.003	0.006	±.002
*21	0.029	0.032	0.035	0.012	±.002	0.010	±.003	0.006	±.002
20	0.032	0.034	0.038	0.016	±.003	0.012	±.003	0.006	±.002
19	0.036	0.038	0.042	0.016	±.003	0.012	±.003	0.006	±.002
18	0.040	0.042	0.046	0.016	±.003	0.012	±.003	0.006	±.002
17	0.045	0.047	0.052	0.016	±.003	0.012	±.003	0.006	±.002
16	0.051	0.053	0.058	0.016	±.003	0.012	±.003	0.006	±.002
15	0.057	0.059	0.065	0.016	±.003	0.012	±.003	0.006	±.002
14	0.064	0.066	0.072	0.016	±.003	0.012	±.003	0.008	±.002
13	0.072	0.076	0.081	0.016	±.003	0.012	±.003	0.008	±.002
12	0.081	0.085	0.091	0.016	±.003	0.012	±.003	0.008	±.002
11	0.091	0.095	0.101	0.016	±.003	0.012	±.003	0.008	±.002
10	0.102	0.106	0.112	0.016	±.003	0.012	±.003	0.008	±.002
9	0.114	0.118	0.124	0.020	±.004	0.015	±.003	0.008	±.002
8	0.129	0.133	0.139	0.020	±.004	0.015	±.003	0.008	±.002
7	0.144	0.148	0.155	0.020	±.004	0.015	±.003	0.008	±.002
6	0.162	0.166	0.174	0.020	±.004	0.015	±.003	0.010	±.003
5	0.182	0.186	0.195	0.020	±.004	0.015	±.003	0.010	±.003
4	0.204	0.208	0.218	0.020	±.004	0.015	±.003	0.010	±.003
3	0.229	0.234	0.244	0.020	±.004	0.015	±.003	0.010	±.003
2	0.258	0.263	0.273	0.020	±.004	0.015	±.003	0.010	±.003
1	0.289	0.294	0.305	0.020	±.004	0.015	±.003	0.010	±.003
0	0.325	0.330	0.342	0.020	±.004	0.015	±.003	0.012	±.003

Lot to lot testing available upon request.

Supplied in natural color unless otherwise specified. Custom colors available on request.

UL-224 and/or CAN/CSA product available upon request.



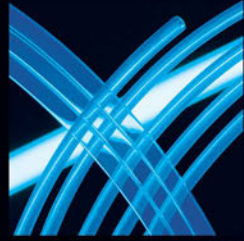

WWW.ZEUSINC.COM

# PTFE, FEP, PFA, ETFE Extruded Tubing

EXTRUDED SIZES



## Metric Dimensions (mm)

AWG Size	INSIDE DIAMETER			WALL DIMENSIONS					
	Min.	Nom.	Max.	Standard Wall Nom.	Standard Wall Tol.	Thin Wall Nom.	Thin Wall Tol.	Lightweight Wall Nom.	Lightweight Wall Tol.
*32	0.20	0.25	0.30	0.13	±.05	0.13	±.05	–	–
30	0.25	0.30	0.38	0.23	±.05	0.23	±.05	0.15	±.05
28	0.33	0.38	0.46	0.23	±.05	0.23	±.05	0.15	±.05
26	0.41	0.46	0.53	0.23	±.05	0.23	±.05	0.15	±.05
24	0.51	0.56	0.66	0.30	±.05	0.25	±.08	0.15	±.05
*23	0.58	0.66	0.74	0.30	±.05	0.25	±.08	0.15	±.05
22	0.64	0.71	0.81	0.30	±.05	0.25	±.08	0.15	±.05
*21	0.74	0.81	0.89	0.30	±.05	0.25	±.08	0.15	±.05
20	0.81	0.86	0.97	0.41	±.08	0.30	±.08	0.15	±.05
19	0.91	0.97	1.07	0.41	±.08	0.30	±.08	0.15	±.05
18	1.02	1.07	1.17	0.41	±.08	0.30	±.08	0.15	±.05
17	1.14	1.19	1.32	0.41	±.08	0.30	±.08	0.15	±.05
16	1.30	1.35	1.47	0.41	±.08	0.30	±.08	0.15	±.05
15	1.45	1.50	1.65	0.41	±.08	0.30	±.08	0.15	±.05
14	1.63	1.68	1.83	0.41	±.08	0.30	±.08	0.20	±.05
13	1.83	1.93	2.06	0.41	±.08	0.30	±.08	0.20	±.05
12	2.06	2.16	2.31	0.41	±.08	0.30	±.08	0.20	±.05
11	2.31	2.41	2.57	0.41	±.08	0.30	±.08	0.20	±.05
10	2.59	2.69	2.84	0.41	±.08	0.30	±.08	0.20	±.05
9	2.90	3.00	3.15	0.51	±.10	0.38	±.08	0.20	±.05
8	3.28	3.38	3.53	0.51	±.10	0.38	±.08	0.20	±.05
7	3.66	3.76	3.94	0.51	±.10	0.38	±.08	0.20	±.05
6	4.11	4.22	4.42	0.51	±.10	0.38	±.08	0.25	±.08
5	4.62	4.72	4.95	0.51	±.10	0.38	±.08	0.25	±.08
4	5.18	5.28	5.54	0.51	±.10	0.38	±.08	0.25	±.08
3	5.82	5.94	6.20	0.51	±.10	0.38	±.08	0.25	±.08
2	6.55	6.68	6.93	0.51	±.10	0.38	±.08	0.25	±.08
1	7.34	7.47	7.75	0.51	±.10	0.38	±.08	0.25	±.08
0	8.26	8.38	8.69	0.51	±.10	0.38	±.08	0.30	±.08

Lot to lot testing available upon request.

Supplied in natural color unless otherwise specified. Custom colors available on request.

UL-224 and/or CAN/CSA product available upon request.



# PTFE, FEP, PFA, ETFE

## Extruded Tubing

EXTRUDED SIZES

### Dimensions (Inches)



INSIDE DIAMETER				WALL DIMENSIONS					
Frac. Sizes Spec'd by ID	Min.	Nom.	Max.	Standard Wall		Thin Wall		Lightweight Wall	
				Nom.	Tol.	Nom.	Tol.	Nom.	Tol.
1/8	0.120	0.125	0.130	0.020	±.004	0.015	±.003	—	—
1/8	0.125	0.130	0.135	—	—	—	—	0.008	±.002
3/16	0.188	0.192	0.198	0.020	±.004	0.015	±.003	0.010	±.003
1/4	0.250	0.255	0.260	0.020	±.004	0.015	±.003	0.010	±.003
5/16	0.313	0.321	0.332	0.020	±.004	0.015	±.003	0.012	±.003
3/8	0.375	0.387	0.394	0.025	±.005	0.015	±.003	0.015	±.005
7/16	0.438	0.451	0.458	0.025	±.005	0.018	±.004	0.018	±.005
1/2	0.500	0.515	0.520	0.025	±.005	0.018	±.004	0.018	±.005
5/8	0.625	0.643	0.650	0.025	±.005	0.020	±.004	0.020	±.005
3/4	0.750	0.772	0.775	0.030	±.006	0.025	±.005	0.020	±.005
7/8	0.875	0.902	0.927	0.035	±.007	—	—	—	—
1	1.000	1.030	1.060	0.035	±.007	—	—	—	—
1-1/4	1.250	1.287	1.325	0.040	±.007	—	—	—	—
1-1/2	1.500	1.550	1.580	0.045	±.007	—	—	—	—

### Metric Dimensions (mm)

INSIDE DIAMETER				WALL DIMENSIONS					
Frac. Sizes Spec'd by ID	Min.	Nom.	Max.	Standard Wall		Thin Wall		Lightweight Wall	
				Nom.	Tol.	Nom.	Tol.	Nom.	Tol.
1/8	3.05	3.18	3.30	0.51	±.10	0.38	±.08	—	—
1/8	3.18	3.30	3.43	—	—	—	—	0.20	±.05
3/16	4.78	4.88	5.03	0.51	±.10	0.38	±.08	0.25	±.08
1/4	6.35	6.48	6.60	0.51	±.10	0.38	±.08	0.25	±.08
5/16	7.95	8.15	8.43	0.51	±.10	0.38	±.08	0.30	±.08
3/8	9.53	9.83	10.01	0.64	±.13	0.38	±.08	0.38	±.13
7/16	11.13	11.46	11.63	0.64	±.13	0.46	±.10	0.46	±.13
1/2	12.70	13.08	13.21	0.64	±.13	0.46	±.10	0.46	±.13
5/8	15.88	16.33	16.51	0.64	±.13	0.51	±.10	0.51	±.13
3/4	19.05	19.61	19.69	0.76	±.15	0.64	±.13	0.51	±.13
7/8	22.23	22.91	23.55	0.89	±.18	—	—	—	—
1	25.40	26.16	26.92	0.89	±.18	—	—	—	—
1-1/4	31.75	32.69	33.66	1.02	±.18	—	—	—	—
1-1/2	38.10	39.37	40.13	1.14	±.18	—	—	—	—



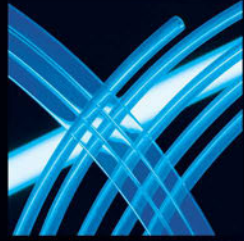

WWW.ZEUSINC.COM

# PTFE, FEP, PFA, ETFE Extruded Tubing

EXTRUDED SIZES



## Dimensions (Inches)

INDUSTRIAL SPECIFICATION TUBING			
Frac. Sizes Spec'd by ID & OD	I.D.	O.D.	Nominal Wall
1/32	0.031 ±.004	0.063 ±.004	.015
1/16	0.063 ±.005	0.125 ±.005	.030
3/32	0.094 ±.005	0.156 ±.005	.030
1/8	0.125 ±.005	0.188 ±.005	.030
3/16	0.188 ±.005	0.250 ±.005	.030
1/4	0.250 ±.005	0.313 ±.005	.030
5/16	0.313 ±.005	0.375 ±.005	.030
3/8	0.375 ±.005	0.438 ±.005	.030
7/16	0.438 ±.005	0.500 ±.006	.030
1/2	0.500 ±.006	0.563 ±.006	.030

INDUSTRIAL SPECIFICATION TUBING			
Frac. Sizes Spec'd by ID & OD	I.D.	O.D.	Nominal Wall
9/16	0.563 ±.006	0.625 ±.006	.030
5/8	0.625 ±.006	0.688 ±.006	.030
11/16	0.688 ±.006	0.750 ±.006	.032
3/4	0.750 ±.006	0.830 ±.006	.040
7/8	0.875 ±.006	0.965 ±.006	.045
1	1.000 ±.010	1.100 ±.010	.050
1-1/8	1.125 ±.015	1.215 ±.015	.045
1-1/4	1.250 ±.015	1.340 ±.015	.045
1-1/2	1.500 ±.015	1.580 ±.015	.040

## Metric Dimensions (mm)

INDUSTRIAL SPECIFICATION TUBING			
Frac. Sizes Spec'd by ID & OD	I.D.	O.D.	Nominal Wall
1/32	0.79 ±0.10	1.60 ±0.10	0.38
1/16	1.60 ±0.13	3.18 ±0.13	0.76
3/32	2.39 ±0.13	3.96 ±0.13	0.76
1/8	3.18 ±0.13	4.78 ±0.13	0.76
3/16	4.78 ±0.13	6.35 ±0.13	0.76
1/4	6.35 ±0.13	7.95 ±0.13	0.76
5/16	7.95 ±0.13	9.53 ±0.13	0.76
3/8	9.53 ±0.13	11.13 ±0.13	0.76
7/16	11.13 ±0.13	12.70 ±0.15	0.76
1/2	12.70 ±0.15	14.30 ±0.15	0.76

INDUSTRIAL SPECIFICATION TUBING			
Frac. Sizes Spec'd by ID & OD	I.D.	O.D.	Nominal Wall
9/16	14.30 ±0.15	15.88 ±0.15	0.76
5/8	15.88 ±0.15	17.48 ±0.15	0.76
11/16	17.48 ±0.15	19.05 ±0.15	0.81
3/4	19.05 ±0.15	21.08 ±0.15	1.02
7/8	22.23 ±0.15	24.51 ±0.15	1.14
1	25.40 ±0.25	27.94 ±0.25	1.27
1-1/8	28.58 ±0.38	30.86 ±0.38	1.14
1-1/4	31.75 ±0.38	34.04 ±0.38	1.14
1-1/2	38.10 ±0.38	40.13 ±0.38	1.02

Lot to lot testing available upon request.

Supplied in natural color unless otherwise specified. Custom colors available on request.

UL-224 and/or CAN/CSA product available upon request.



# PTFE, FEP, PFA, ETFE

## Heavy Construction Tubing

EXTRUDED SIZES



### Dimensions (Inches)

Fractional Spec'd by OD	O.D.	I.D.	Nominal Wall Thickness
1/4	0.250 ±.005	0.125 ±.005	0.063
5/16	0.313 ±.005	0.188 ±.005	0.063
3/8	0.375 ±.005	0.250 ±.005	0.063
7/16	0.438 ±.005	0.313 ±.005	0.063
1/2	0.500 ±.006	0.375 ±.006	0.063
9/16	0.563 ±.006	0.438 ±.006	0.063
5/8	0.625 ±.006	0.500 ±.006	0.063
11/16	0.688 ±.006	0.563 ±.006	0.063
3/4	0.750 ±.006	0.625 ±.006	0.063
13/16	0.813 ±.006	0.688 ±.006	0.063
7/8	0.875 ±.006	0.750 ±.006	0.063
15/16	0.938 ±.006	0.813 ±.006	0.063
1	1.000 ±.010	0.875 ±.010	0.063

### Metric Dimensions (mm)

Fractional Spec'd by OD	O.D.	I.D.	Nominal Wall Thickness
1/4	6.35 ±.13	3.18 ±.13	1.60
5/16	7.92 ±.13	4.78 ±.13	1.60
3/8	9.52 ±.13	6.35 ±.13	1.60
7/16	11.13 ±.13	7.95 ±.13	1.60
1/2	12.70 ±.15	9.52 ±.15	1.60
9/16	14.30 ±.15	11.13 ±.15	1.60
5/8	15.88 ±.15	12.70 ±.15	1.60
11/16	17.48 ±.15	14.30 ±.15	1.60
3/4	19.05 ±.15	15.88 ±.15	1.60
13/16	20.65 ±.15	17.48 ±.15	1.60
7/8	22.23 ±.15	19.05 ±.15	1.60
15/16	23.83 ±.15	20.65 ±.15	1.60
1	25.40 ±.25	22.23 ±.25	1.60





WWW.ZEUSINC.COM

# PTFE, FEP, PFA, ETFE

## Heavy Wall Tubing

EXTRUDED SIZES



### Dimensions (Inches)

AWG	INSIDE DIAMETER			WALL DIMENSIONS	
	ID Minimum	ID Nominal	ID Maximum	Wall Nominal	Tolerance
24	0.020	0.022	0.026	0.016	± .003
23	0.024	0.027	0.030	0.016	± .003
22	0.025	0.029	0.032	0.016	± .003
21	0.030	0.033	0.036	0.016	± .003
20	0.032	0.036	0.040	0.018	± .003
19	0.036	0.040	0.044	0.020	± .004
18	0.040	0.045	0.049	0.020	± .004
17	0.045	0.050	0.054	0.020	± .004
16	0.051	0.056	0.061	0.020	± .004
15	0.057	0.062	0.067	0.020	± .004
14	0.064	0.069	0.074	0.020	± .004
13	0.072	0.077	0.082	0.020	± .004
12	0.081	0.086	0.091	0.020	± .004
11	0.091	0.096	0.101	0.020	± .004
10	0.102	0.107	0.112	0.025	± .005
9	0.114	0.119	0.124	0.025	± .005
8	0.129	0.135	0.141	0.030	± .005
7	0.144	0.151	0.158	0.030	± .005
6	0.162	0.170	0.178	0.030	± .005
5	0.182	0.190	0.198	0.032	± .005

Fractional Spec'd by ID/OD	O.D.	I.D.	Nominal Wall Thickness
5/32*	0.250 ±.005	0.156 ±.005	0.047

\* This product is specified as HW and dimensionally manufactured to ID/OD.

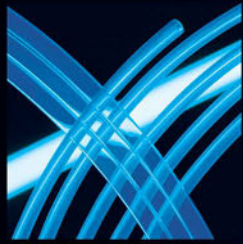

WWW.ZEUSINC.COM

# PTFE Monofilament

EXTRUDED SIZES

## Dimensions (Inches)

Ordered As Diameter	Tolerances
0.028	±.002
0.031	±.002
0.035	±.002
0.039	±.002
0.047	±.002
0.050	±.002
0.055	±.002
0.062	±.002
0.070	±.002
0.078	±.003
0.094	±.003
0.100	±.003
0.109	±.003
0.125	±.003
0.150	±.003

## Metric Dimensions (mm)

Ordered As Diameter	Tolerances
0.71	±.05
0.79	±.05
0.89	±.05
0.99	±.05
1.19	±.05
1.27	±.05
1.40	±.05
1.57	±.05
1.78	±.05
1.98	±.08
2.39	±.08
2.54	±.08
2.77	±.08
3.17	±.08
3.81	±.08



Supplied in natural unless otherwise specified. Custom colors available on request.. Lot to lot testing available upon request.





WWW.ZEUSINC.COM

# Convoluting Tubing

## PTFE

EXTRUDED SIZES



### Standard Flex Convoluting

Part Number	Identifier	Max I.D.	Min I.D.	Max O.D.	Max. Wall Thick	Conv/Inch ±1"	Weight (LBS) Per CFT Maximum	Min. Bend Radius
ZCT-TS-012	**01	0.188	0.181	0.320	0.023	8	2.0	0.500
ZCT-TS-018	**02	0.281	0.273	0.414	0.027	7 1/2	2.9	0.750
ZCT-TS-020	**03	0.312	0.303	0.450	0.027	7 1/2	3.6	0.875
ZCT-TS-024	**04	0.375	0.364	0.530	0.029	7	4.2	1.000
ZCT-TS-028	**05	0.437	0.425	0.590	0.029	7	4.9	1.250
ZCT-TS-032	**06	0.500	0.485	0.660	0.029	7	5.2	1.500
ZCT-TS-040	**07	0.625	0.608	0.780	0.035	7	6.9	1.750
ZCT-TS-048	**08	0.750	0.730	0.975	0.035	6	10.4	1.875
ZCT-TS-056	**09	0.875	0.850	1.100	0.035	6	11.3	2.250
ZCT-TS-064	**10	1.000	0.975	1.260	0.035	4 1/2	12.6	2.500
ZCT-TS-072	**11	1.125	1.105	1.390	0.035	4 1/2	13.8	2.750
ZCT-TS-080	**12	1.250	1.210	1.539	0.035	4	15.5	3.000
ZCT-TS-096*	**13	1.500	1.440	1.850	0.040	4	21.7	3.750

### Extra Flex Convoluting

Part Number	Identifier	Max I.D.	Min I.D.	Max O.D.	Max. Wall Thick	Conv/Inch ±1"	Weight (LBS) Per CFT Maximum	Min. Bend Radius
ZCT-TE-012	**01	0.188	0.181	0.32	0.023	10	2.2	0.313
ZCT-TE-018	**02	0.281	0.273	0.414	0.026	9	3.8	0.438
ZCT-TE-020	**03	0.312	0.306	0.450	0.027	9	4.8	0.438
ZCT-TE-024	**04	0.375	0.364	0.530	0.029	9	5.6	0.500
ZCT-TE-028	**05	0.437	0.427	0.590	0.029	9	6.5	0.500
ZCT-TE-032	**06	0.500	0.485	0.660	0.029	9	6.9	0.750
ZCT-TE-040	**07	0.625	0.608	0.780	0.035	9	9.2	0.750
ZCT-TE-048	**08	0.750	0.730	0.975	0.035	8	13.8	0.938
ZCT-TE-056	**09	0.875	0.860	1.100	0.035	8	15	0.938
ZCT-TE-064	**10	1.000	0.975	1.260	0.035	7	16.8	1.125
ZCT-TE-072	**11	1.125	1.105	1.390	0.035	6	17.5	1.125
ZCT-TE-080	**12	1.250	1.210	1.539	0.035	6	19.6	1.250
ZCT-TE-096*	**13	1.500	1.450	1.810	0.038	6	26	2.000

The tables above detail Zeus part numbers, materials, and dimensions for our standard and extra flex PTFE convoluting tubing.



WWW.ZEUSINC.COM

# Convolved Tubing

## FEP

EXTRUDED SIZES



### Standard Flex Convolved

Part Number	Identifier	Max I.D.	Min I.D.	Max O.D.	Max. Wall Thick	Conv/Inch ±1"	Weight (LBS) Per CFT Maximum	Min. Bend Radius
ZCT-FS-012	**01	0.188	0.181	0.320	0.018	8	1.5	0.500
ZCT-FS-018	**02	0.281	0.273	0.414	0.018	8	1.7	0.750
ZCT-FS-020	**03	0.312	0.306	0.450	0.018	8	1.9	0.750
ZCT-FS-024	**04	0.375	0.364	0.510	0.018	8	2.2	0.875
ZCT-FS-028	**05	0.437	0.427	0.571	0.018	8	3.1	0.875
ZCT-FS-032	**06	0.500	0.485	0.650	0.023	7	4.0	1.250
ZCT-FS-040	**07	0.625	0.608	0.770	0.023	7	4.8	1.500
ZCT-FS-048	**08	0.750	0.730	0.930	0.023	6	6.1	1.750
ZCT-FS-056	**09	0.875	0.860	1.073	0.023	5	7.0	2.000
ZCT-FS-064	**10	1.000	.975	1.226	0.023	5	8.5	2.370
ZCT-FS-072	**11	1.125	1.105	1.390	0.023	5	9.3	2.370
ZCT-FS-080	**12	1.250	1.210	1.539	0.023	4	10.9	2.750
ZCT-FS-096	**13	1.500	1.437	1.832	0.023	4	12.6	3.375

### Extra Flex Convolved

Part Number	Identifier	Max I.D.	Min I.D.	Max O.D.	Max. Wall Thick	Conv/Inch ±1"	Weight (LBS) Per CFT Maximum	Min. Bend Radius
ZCT-FE-012	**01	0.188	0.181	0.320	0.018	10	1.7	0.310
ZCT-FE-018	**02	0.281	0.273	0.414	0.018	10	2.0	0.410
ZCT-FE-020	**03	0.312	0.306	0.450	0.018	10	2.1	0.410
ZCT-FE-024	**04	0.375	0.359	0.510	0.018	10	2.5	0.500
ZCT-FE-028	**05	0.437	0.427	0.571	0.018	10	3.9	0.500
ZCT-FE-032	**06	0.500	0.480	0.650	0.023	9	4.6	0.750
ZCT-FE-040	**07	0.625	0.603	0.770	0.023	9	5.5	0.750
ZCT-FE-048	**08	0.750	0.725	0.930	0.023	8	6.9	0.930
ZCT-FE-056	**09	0.875	0.860	1.073	0.023	7	8.9	1.250
ZCT-FE-064	**10	1.000	0.970	1.226	0.023	7	9.5	1.250
ZCT-FE-072	**11	1.125	1.105	1.390	0.023	7	10.5	1.430
ZCT-FE-080	**12	1.250	1.205	1.539	0.023	6.5	11.2	1.430
ZCT-FE-096	**13	1.500	1.437	1.832	0.023	5.5	12.0	1.750

The tables above detail Zeus part numbers, materials, and dimensions for our standard and extra flex FEP convolved tubing.



# Convuluted Tubing

## ETFE

EXTRUDED SIZES



### Standard Flex Convuluted

Part Number	Identifier	Max I.D.	Min I.D.	Max O.D.	Max. Wall Thick	Conv/Inch ±1"	Weight (LBS) Per CFT Maximum	Min. Bend Radius
ZCT-ES-012	**01	0.188	0.181	0.320	0.018	8	1.2	0.500
ZCT-ES-018	**02	0.281	0.273	0.414	0.018	8	1.4	0.750
ZCT-ES-020	**03	0.312	0.306	0.450	0.018	8	1.5	0.750
ZCT-ES-024	**04	0.375	0.364	0.510	0.018	8	1.8	0.880
ZCT-ES-028	**05	0.437	0.427	0.571	0.018	8	2.5	0.880
ZCT-ES-032	**06	0.500	0.485	0.650	0.023	7	3.2	1.250
ZCT-ES-040	**07	0.625	0.608	0.770	0.023	7	3.9	1.500
ZCT-ES-048	**08	0.750	0.730	0.930	0.023	6	4.9	1.750
ZCT-ES-056	**09	0.875	0.860	1.073	0.023	5	5.6	2.000
ZCT-ES-064	**10	1.000	0.975	1.226	0.023	5	6.8	2.370
ZCT-ES-072	**11	1.125	1.105	1.390	0.023	5	7.5	2.370
ZCT-ES-080	**12	1.250	1.210	1.539	0.023	4	8.8	2.750
ZCT-ES-096	**13	1.500	1.437	1.832	0.023	4	10.2	3.380

### Extra Flex Convuluted

Part Number	Identifier	Max I.D.	Min I.D.	Max O.D.	Max. Wall Thick	Conv/Inch ±1"	Weight (LBS) Per CFT Maximum	Min. Bend Radius
ZCT-EE-012	**01	0.188	0.181	0.320	0.018	10	1.4	0.310
ZCT-EE-018	**02	0.281	0.273	0.414	0.018	10	1.6	0.410
ZCT-EE-020	**03	0.312	0.306	0.450	0.018	10	1.7	0.410
ZCT-EE-024	**04	0.375	0.359	0.510	0.018	10	2.0	0.500
ZCT-EE-028	**05	0.437	0.427	0.571	0.018	10	3.1	0.500
ZCT-EE-032	**06	0.500	0.480	0.650	0.023	9	3.7	0.750
ZCT-EE-040	**07	0.625	0.603	0.770	0.023	9	4.4	0.750
ZCT-EE-048	**08	0.750	0.725	0.930	0.023	8	5.6	0.930
ZCT-EE-056	**09	0.875	0.860	1.073	0.023	7	7.1	1.250
ZCT-EE-064	**10	1.000	0.970	1.226	0.023	7	7.6	1.250
ZCT-EE-072	**11	1.125	1.105	1.390	0.023	7	8.4	1.430
ZCT-EE-080	**12	1.250	1.205	1.539	0.023	6	9.0	1.430
ZCT-EE-096	**13	1.500	1.437	1.832	0.023	5	9.6	1.750

The tables above detail Zeus part numbers, materials, and dimensions for our standard and extra flex ETFE convuluted tubing.





# PTFE, FEP, PFA & ETFE Spiral-Cut Cable Wrap

EXTRUDED SIZES



## Dimensions (inches)

Ordered by Outside Diameter A	Cut From PTFE, FEP, PFA, ETFE Industrial Tubing Size I.D. B	Wall C	Bundle Diameter Maximum D	Pitch of Helical Cut E
1/8 (0.125)	1/16	0.030	1/2	(0.218)
3/16 (0.188)	1/8	0.030	1	(0.312)
1/4 (0.250)	3/16	0.030	2	(0.375)
5/16 (0.313)	1/4	0.030	2-1/2	(0.375)
3/8 (0.375)	5/16	0.030	3	(0.437)
1/2 (0.500)	7/16	0.030	4	(0.562)
5/8 (0.625)	9/16	0.030	5	(0.625)
3/4 (0.750)	11/16	0.035	6	(0.875)
1 (1.000)	15/16	0.040	8	(1.000)

## Metric Dimensions (mm)

Ordered by Outside Diameter A	Cut From PTFE, FEP, PFA, ETFE Industrial Tubing Size I.D. B	Wall C	Bundle Diameter Maximum D	Pitch of Helical Cut E
3.18	1.59	0.76	12.70	5.54
4.78	3.18	0.76	25.40	7.92
6.35	4.76	0.76	50.80	9.53
7.94	6.35	0.76	63.50	9.53
9.53	7.94	0.76	76.20	11.11
12.70	11.11	0.76	101.60	14.27
15.88	14.29	0.76	127.00	15.88
19.05	17.46	0.89	152.40	22.23
25.40	23.81	1.02	203.20	25.40

Supplied in natural unless otherwise specified.  
Custom colors available on request.

OD tolerance  $\pm .005"$ , Wall Tolerance  $\pm .005"$ ,  
Pitch Tolerance  $\pm .030"$ .

Lot to lot testing available upon request.

ZEUS SPIRAL-CUT CABLE WRAPS are expandable abrasion-resistant wraps for harnessing and insulating wires, cable, and bundles. ZEUS SPIRAL CUT CABLE WRAP is extruded to close tolerances and then precision cut.

Use chart and letters shown when ordering

"A" = O.D. of PTFE Tubing

"B" = I.D.

"C" = Wall Thickness

"D" = Maximum Bundle Diameter

"E" = Pitch

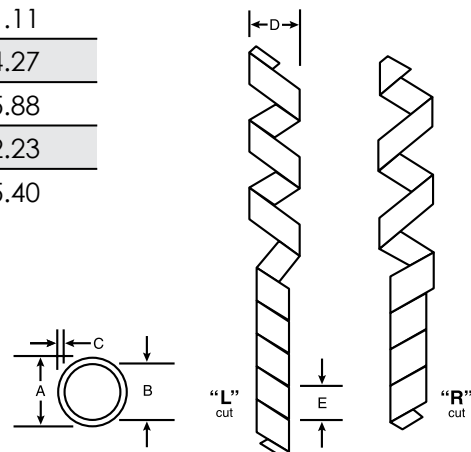
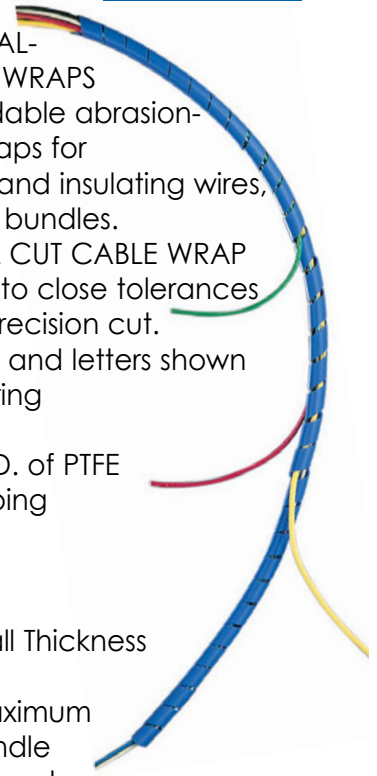



# PTFE, FEP, PFA, ETFE

## Extruded Metric Tubing

### 0.50mm Wall Tubing

EXTRUDED SIZES



Ordering Size (ID/OD)	I.D.	Tolerance + / -	Wall Thickness
0.50/1.50	0.50	0.05	0.50 ±0.07
1.00/2.00	1.00	0.05	0.50 ±0.07
1.50/2.50	1.50	0.10	0.50 ±0.07
2.00/3.00	2.00	0.10	0.50 ±0.07
2.50/3.50	2.50	0.15	0.50 ±0.07
3.00/4.00	3.00	0.15	0.50 ±0.07
3.50/4.50	3.50	0.15	0.50 ±0.07
4.00/5.00	4.00	0.15	0.50 ±0.07
4.50/5.50	4.50	0.20	0.50 ±0.07
5.00/6.00	5.00	0.20	0.50 ±0.07
5.50/6.50	5.50	0.20	0.50 ±0.07
6.00/7.00	6.00	0.20	0.50 ±0.07
6.50/7.50	6.50	0.20	0.50 ±0.07
7.00/8.00	7.00	0.20	0.50 ±0.07
7.50/8.50	7.50	0.20	0.50 ±0.07
8.00/9.00	8.00	0.20	0.50 ±0.07
8.50/9.50	8.50	0.30	0.50 ±0.07
9.00/10.00	9.00	0.30	0.50 ±0.07
12.00/13.00	12.00	0.30	0.50 ±0.07
13.00/14.00	13.00	0.50	0.50 ±0.07

Supplied in natural unless otherwise specified. Custom colors available on request.



# PTFE, FEP, PFA, ETFE

## Extruded Metric Tubing

### 1.00mm Wall Tubing

EXTRUDED SIZES



### 1.00mm Wall Tubing

Ordering Size (ID/OD)	I.D.	Tolerance + / -	Wall Thickness
1.00/3.00	1.00	0.05	1.00 ±0.15
2.00/4.00	2.00	0.10	1.00 ±0.15
2.50/4.50	2.50	0.15	1.00 ±0.15
3.00/5.00	3.00	0.15	1.00 ±0.15
3.50/5.50	3.50	0.15	1.00 ±0.15
4.00/6.00	4.00	0.15	1.00 ±0.15
4.50/6.50	4.50	0.20	1.00 ±0.15
5.00/7.00	5.00	0.20	1.00 ±0.15
5.50/7.50	5.50	0.20	1.00 ±0.15
6.00/8.00	6.00	0.20	1.00 ±0.15
6.50/8.50	6.50	0.20	1.00 ±0.15
7.00/9.00	7.00	0.20	1.00 ±0.15
7.50/9.50	7.50	0.20	1.00 ±0.15
8.00/10.00	8.00	0.20	1.00 ±0.15
8.50/10.50	8.50	0.30	1.00 ±0.15
9.00/11.00	9.00	0.30	1.00 ±0.15
9.50/11.50	9.50	0.30	1.00 ±0.15
10.00/12.00	10.00	0.30	1.00 ±0.15
10.50/12.50	10.50	0.30	1.00 ±0.15
11.00/13.00	11.00	0.30	1.00 ±0.15
12.00/14.00	12.00	0.30	1.00 ±0.15
13.00/15.00	13.00	0.30	1.00 ±0.15
14.00/16.00	14.00	0.30	1.00 ±0.15
15.00/17.00	15.00	0.40	1.00 ±0.15
16.00/18.00	16.00	0.40	1.00 ±0.15
18.00/20.00	18.00	0.40	1.00 ±0.15
19.00/21.00	19.00	0.40	1.00 ±0.15
19.50/21.50	19.50	0.40	1.00 ±0.15

Ordering Size (ID/OD)	I.D.	Tolerance + / -	Wall Thickness
20.00/22.00	20.00	0.40	1.00 ±0.15
21.00/23.00	21.00	0.50	1.00 ±0.15
22.00/24.00	22.00	0.50	1.00 ±0.15
22.50/24.50	22.50	0.50	1.00 ±0.15
23.00/25.00	23.00	0.50	1.00 ±0.15
23.50/25.50	23.50	0.50	1.00 ±0.15
25.00/27.00	25.00	0.50	1.00 ±0.15
26.00/28.00	26.00	0.50	1.00 ±0.15
27.00/29.00	27.00	0.50	1.00 ±0.15
28.00/30.00	28.00	0.50	1.00 ±0.15
29.00/31.00	29.00	0.50	1.00 ±0.15
30.00/32.00	30.00	0.60	1.00 ±0.15
32.00/34.00	32.00	0.60	1.00 ±0.15
37.00/39.00	37.00	0.60	1.00 ±0.15
38.00/40.00	38.00	0.60	1.00 ±0.15
40.00/42.00	40.00	0.75	1.00 ±0.15
42.00/44.00	42.00	0.75	1.00 ±0.15
43.00/45.00	43.00	0.75	1.00 ±0.15
45.00/47.00	45.00	0.75	1.00 ±0.15
45.50/47.50	45.50	0.75	1.00 ±0.15
48.00/50.00	48.00	0.75	1.00 ±0.15
50.00/52.00	50.00	0.75	1.00 ±0.15

Supplied in natural unless otherwise specified. Custom colors available on request.





WWW.ZEUSINC.COM

# PTFE, FEP, PFA, ETFE

## Extruded Metric Tubing

### 1.50/2.00mm Wall Tubing

EXTRUDED SIZES



#### 1.50mm Wall Tubing

Ordering Size (ID/OD)	I.D.	Tolerance + / -	Wall Thickness
1.50/4.50	1.50	0.10	1.50 ±0.20
2.00/5.00	2.00	0.15	1.50 ±0.20
3.00/6.00	3.00	0.15	1.50 ±0.20
5.00/8.00	5.00	0.20	1.50 ±0.20
6.00/9.00	6.00	0.20	1.50 ±0.20
10.00/13.00	10.00	0.30	1.50 ±0.20
12.00/15.00	12.00	0.30	1.50 ±0.20
13.00/16.00	13.00	0.30	1.50 ±0.20
14.00/17.00	14.00	0.30	1.50 ±0.20
16.00/19.00	16.00	0.40	1.50 ±0.20
18.00/21.00	18.00	0.40	1.50 ±0.20
19.00/22.00	19.00	0.40	1.50 ±0.20
20.00/23.00	20.00	0.50	1.50 ±0.20
21.00/24.00	21.00	0.50	1.50 ±0.20
22.00/25.00	22.00	0.50	1.50 ±0.20
25.00/28.00	25.00	0.50	1.50 ±0.20
28.00/31.00	28.00	0.50	1.50 ±0.20
29.00/32.00	29.00	0.50	1.50 ±0.20
30.00/33.00	30.00	0.60	1.50 ±0.20
40.00/43.00	40.00	0.75	1.50 ±0.20
49.00/52.00	49.00	0.75	1.50 ±0.20

#### 2.00mm Wall Tubing

Ordering Size (ID/OD)	I.D.	Tolerance + / -	Wall Thickness
2.00/6.00	2.00	0.10	2.00 ±0.20
4.00/8.00	4.00	0.15	2.00 ±0.20
6.00/10.00	6.00	0.20	2.00 ±0.20
8.00/12.00	8.00	0.20	2.00 ±0.20
10.00/14.00	10.00	0.30	2.00 ±0.20
12.00/16.00	12.00	0.30	2.00 ±0.20
14.00/18.00	14.00	0.40	2.00 ±0.20
16.00/20.00	16.00	0.40	2.00 ±0.20
20.00/24.00	20.00	0.50	2.00 ±0.20
25.00/29.00	25.00	0.50	2.00 ±0.20
28.00/32.00	28.00	0.50	2.00 ±0.20
28.50/32.50	28.50	0.50	2.00 ±0.20
32.00/36.00	32.00	0.60	2.00 ±0.20
36.00/40.00	36.00	0.60	2.00 ±0.20
40.00/44.00	40.00	0.75	2.00 ±0.20
46.00/50.00	46.00	0.75	2.00 ±0.20

Supplied in natural unless otherwise specified. Custom colors available on request.



# ZEUS<sup>®</sup>

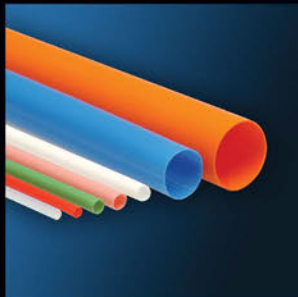

## HEAT SHRINKABLE EXTRUSIONS



HEAT SHRINKABLE EXTRUSIONS



WWW.ZEUSINC.COM

# ZEUS Heat Shrink Fluoropolymer Tubing

HEAT SHRINKABLE EXTRUSIONS

ZEUS heat shrink tubing offers a unique combination of properties in its tubing, including outstanding electrical characteristics; excellent chemical and solvent resistances; purity; lubricity and outstanding performance reliability.



ZEUS has mastered the art of manufacturing fluoropolymer heat shrink tubing and can supply it with recovered walls as thin as .002". Please contact a ZEUS representative to learn more about customer sizes, packaging, lengths and colors.

## Heat Shrink Application Tips

1. Always assure good ventilation in the immediate work area prior to beginning the heat shrinking process.

**Caution:** Fumes may cause nausea and dizziness.

2. The mandrel to be covered by the heat shrink must be able to withstand the required temperature for material recovery (see table at right).
3. The mandrel being covered may act as a heat sink (especially metal mandrels). Therefore, ZEUS recommends preheating mandrels.
4. Heat shrink should be allowed to recover a minimum of 20%. Highly restricted radial recovery tends to induce longitudinal change and increase the tendency for splitting.

## TOP VIEW - ROLLER IN LATHE

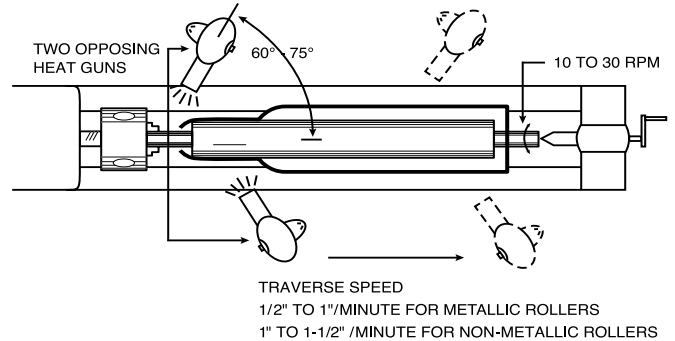

## SAME PROCEDURE APPLIES FOR MANUAL ROTATION

5. Ovens are the most reliable way to recover heat shrink products due to their ability to ensure even heating and reduce the risk of over heating the material which can lead to brittleness and cracking. If a heat gun will be used please refer to the picture above illustrating the proper application of heat to achieve the most uniform recovery.
6. See Chart for recovery temperatures.

HEAT SHRINK RECOVERY TEMPERATURE	
Material	Recovery Temperature
PTFE	654°F - 670°F 346°C - 354°C
FEP (1" ID or less)	400°F - 420°F 204°C - 216°C
FEP (1" ID or greater)	420°F - 440°F 216°C - 227°C

The heat shrink temperatures listed in this catalog are general guidelines. Actual shrink temperatures may be higher or lower depending on the design and dimensions of the heat shrink, application techniques and other factors. Please contact a ZEUS Technical Account Manager for more information.





# PTFE Heat Shrink

## 2 to 1 Shrink Ratio

Approximate Ratio of Expanded I.D. to Recovered I.D. – AWG Sizes

WWW.ZEUSINC.COM

HEAT SHRINKABLE EXTRUSIONS



### Dimensions (inches)

STANDARD WALL					THIN WALL					LIGHTWEIGHT WALL				
Ordered as AWG Size No.	Expanded I.D. Min.	Recovered I.D. Max	Recovered Wall Thickness Nom.	Recovered Wall Thickness Tol.	Ordered as AWG Size No.	Expanded I.D. Min	Recovered I.D. Max	Recovered Wall Thickness Nom.	Recovered Wall Thickness Tol.	Ordered as AWG Size No.	Expanded I.D. Min	Recovered I.D. Max	Recovered Wall Thickness Nom.	Recovered Wall Thickness Tol.
30*	0.034	0.015	0.009	±.002	30	0.034	0.015	0.009	±.002	30*	0.034	0.015	0.006	±.002
28*	0.038	0.018	0.009	±.002	28	0.038	0.018	0.009	±.002	28*	0.038	0.018	0.006	±.002
26*	0.046	0.022	0.010	±.002	26	0.046	0.022	0.010	±.002	26*	0.046	0.022	0.006	±.002
24	0.050	0.027	0.012	±.002	24	0.050	0.027	0.010	±.002	24	0.050	0.025	0.006	±.002
22	0.055	0.032	0.012	±.002	22	0.055	0.032	0.012	±.003	22	0.055	0.031	0.006	±.002
20	0.060	0.039	0.016	±.003	20	0.060	0.039	0.012	±.003	20	0.060	0.038	0.006	±.002
19	0.065	0.043	0.016	±.003	19	0.065	0.043	0.012	±.003	19	0.065	0.043	0.006	±.002
18	0.076	0.049	0.016	±.003	18	0.076	0.049	0.012	±.003	18	0.076	0.046	0.006	±.002
17	0.085	0.054	0.016	±.003	17	0.085	0.054	0.012	±.003	17	0.085	0.054	0.006	±.002
16	0.093	0.061	0.016	±.003	16	0.093	0.061	0.012	±.003	16	0.093	0.057	0.006	±.002
15	0.110	0.067	0.016	±.003	15	0.110	0.067	0.012	±.003	15	0.110	0.063	0.006	±.002
14	0.120	0.072	0.016	±.003	14	0.120	0.072	0.012	±.003	14	0.120	0.072	0.008	±.002
13	0.140	0.080	0.016	±.003	13	0.140	0.080	0.012	±.003	13	0.140	0.080	0.008	±.002
12	0.150	0.089	0.016	±.003	12	0.150	0.089	0.012	±.003	12	0.150	0.089	0.008	±.002
11	0.170	0.101	0.016	±.003	11	0.170	0.101	0.012	±.003	11	0.170	0.099	0.008	±.002
10	0.191	0.112	0.016	±.003	10	0.191	0.112	0.012	±.003	10	0.191	0.110	0.008	±.002
9	0.205	0.124	0.020	±.004	9	0.205	0.124	0.015	±.004	9	0.205	0.122	0.008	±.002
8	0.240	0.141	0.020	±.004	8	0.240	0.141	0.015	±.004	8	0.240	0.139	0.008	±.002
7	0.270	0.158	0.020	±.004	7	0.270	0.158	0.015	±.004	7	0.270	0.154	0.008	±.002
6	0.302	0.178	0.020	±.004	6	0.302	0.178	0.015	±.004	6	0.302	0.172	0.010	±.003
5	0.320	0.198	0.020	±.004	5	0.320	0.198	0.015	±.004	5	0.320	0.192	0.010	±.003
4	0.370	0.224	0.020	±.004	4	0.370	0.224	0.015	±.004	4	0.370	0.214	0.010	±.003
3	0.390	0.249	0.020	±.004	3	0.390	0.249	0.015	±.004	3	0.390	0.241	0.010	±.003
2	0.430	0.278	0.020	±.004	2	0.430	0.278	0.015	±.004	2	0.430	0.270	0.010	±.003
1	0.450	0.311	0.020	±.004	1	0.450	0.311	0.015	±.004	1	0.450	0.301	0.010	±.003
0	0.470	0.347	0.020	±.004	0	0.470	0.347	0.015	±.004	0	0.470	0.347	0.012	±.003

AS 23053/12 product available upon request.

\*AWG 30, 28, 26 SW and LW are not covered under AS23053/12.

PACKAGING: Standard 4ft lengths, unless otherwise specified. Custom colors available on request.

Colors for AS23053/12 product produced in accordance with MIL-STD-104 available upon request.



# PTFE Heat Shrink

## 2 to 1 Shrink Ratio

Approximate Ratio of Expanded I.D. to Recovered I.D. – AWG Sizes

WWW.ZEUSINC.COM

HEAT SHRINKABLE EXTRUSIONS

### Metric Dimensions (mm)



STANDARD WALL					THIN WALL					LIGHTWEIGHT WALL				
Ordered as AWG Size No.	Expanded I.D. Min.	Recovered I.D. Max	Recovered Wall Thickness Nom.	Recovered Wall Thickness Tol.	Ordered as AWG Size No.	Expanded I.D. Min	Recovered I.D. Max	Recovered Wall Thickness Nom.	Recovered Wall Thickness Tol.	Ordered as AWG Size No.	Expanded I.D. Min	Recovered I.D. Max	Recovered Wall Thickness Nom.	Recovered Wall Thickness Tol.
30*	0.86	0.38	0.23	±.05	30	0.86	0.38	0.23	±.05	30*	0.86	0.38	0.15	±.05
28*	0.96	0.46	0.23	±.05	28	0.96	0.46	0.23	±.05	28*	0.96	0.46	0.15	±.05
26*	1.17	0.56	0.25	±.05	26	1.17	0.56	0.25	±.05	26*	1.17	0.56	0.15	±.05
24	1.27	0.69	0.30	±.05	24	1.27	0.69	0.25	±.05	24	1.27	0.64	0.15	±.05
22	1.40	0.81	0.30	±.05	22	1.40	0.81	0.30	±.08	22	1.40	0.79	0.15	±.05
20	1.52	0.99	0.41	±.08	20	1.52	0.99	0.30	±.08	20	1.52	0.97	0.15	±.05
19	1.65	1.09	0.41	±.08	19	1.65	1.09	0.30	±.08	19	1.65	1.09	0.15	±.05
18	1.93	1.24	0.41	±.08	18	1.93	1.24	0.30	±.08	18	1.93	1.17	0.15	±.05
17	2.16	1.37	0.41	±.08	17	2.16	1.37	0.30	±.08	17	2.16	1.37	0.15	±.05
16	2.36	1.55	0.41	±.08	16	2.36	1.55	0.30	±.08	16	2.36	1.45	0.15	±.05
15	2.79	1.70	0.41	±.08	15	2.79	1.70	0.30	±.08	15	2.79	1.60	0.15	±.05
14	3.05	1.83	0.41	±.08	14	3.05	1.83	0.30	±.08	14	3.05	1.83	0.20	±.05
13	3.56	2.03	0.41	±.08	13	3.56	2.03	0.30	±.08	13	3.56	2.03	0.20	±.05
12	3.81	2.26	0.41	±.08	12	3.81	2.26	0.30	±.08	12	3.81	2.26	0.20	±.05
11	4.32	2.57	0.41	±.08	11	4.32	2.57	0.30	±.08	11	4.32	2.51	0.20	±.05
10	4.85	2.84	0.41	±.08	10	4.85	2.84	0.30	±.08	10	4.85	2.79	0.20	±.05
9	5.21	3.15	0.51	±.10	9	5.21	3.15	0.38	±.10	9	5.21	3.10	0.20	±.05
8	6.10	3.58	0.51	±.10	8	6.10	3.58	0.38	±.10	8	6.10	3.53	0.20	±.05
7	6.86	4.01	0.51	±.10	7	6.86	4.01	0.38	±.10	7	6.86	3.91	0.20	±.05
6	7.67	4.52	0.51	±.10	6	7.67	4.52	0.38	±.10	6	7.67	4.37	0.25	±.08
5	8.13	5.03	0.51	±.10	5	8.13	5.03	0.38	±.10	5	8.13	4.88	0.25	±.08
4	9.40	5.69	0.51	±.10	4	9.40	5.69	0.38	±.10	4	9.40	5.44	0.25	±.08
3	9.91	6.32	0.51	±.10	3	9.91	6.32	0.38	±.10	3	9.91	6.12	0.25	±.08
2	10.92	7.06	0.51	±.10	2	10.92	7.06	0.38	±.10	2	10.92	6.86	0.25	±.08
1	11.43	7.90	0.51	±.10	1	11.43	7.90	0.38	±.10	1	11.43	7.65	0.25	±.08
0	11.94	8.81	0.51	±.10	0	11.94	8.81	0.38	±.10	0	11.94	8.81	0.30	±.08

AS 23053/12 product available upon request.

\*AWG 30, 28, 26 SW and LW are not covered under AS23053/12.

**PACKAGING:** Standard 4ft lengths, unless otherwise specified. Custom colors available on request.

Colors for AS23053/12 product produced in accordance with MIL-STD-104 available upon request.



WWW.ZEUSINC.COM

# PTFE Heat Shrink

## 2 to 1 Shrink Ratio

Approximate Ratio of Expanded I.D. to Recovered I.D. – Fractional Inch Sizes

HEAT SHRINKABLE EXTRUSIONS



### Dimensions (inches)

STANDARD WALL					THIN WALL					INDUSTRIAL WALL				
Ordered as AWG Size No.	Expanded I.D. Min.	Recovered I.D. Max.	Recovered Wall Thickness		Ordered as AWG Size No.	Expanded I.D. Min.	Recovered I.D. Max.	Recovered Wall Thickness		Ordered as AWG Size No.	Expanded I.D. Min.	Recovered I.D. Max.	Recovered Wall Thickness	
			Nom.	Tol.				Nom.	Tol.				Nom.	Tol.
1/8	0.215	0.130	0.020	±.004	1/8	0.215	0.130	0.015	±.003	1/8	0.166	0.130	0.030	±.005
1/4	0.410	0.260	0.020	±.004	1/4	0.410	0.260	0.015	±.003	3/16	0.250	0.193	0.030	±.005
5/16	0.470	0.329	0.020	±.004	5/16	0.470	0.329	0.015	±.003	1/4	0.333	0.257	0.030	±.005
3/8	0.560	0.399	0.025	±.006	3/8	0.560	0.399	0.015	±.003	5/16	0.415	0.320	0.030	±.005
7/16	0.655	0.462	0.025	±.006	7/16	0.655	0.462	0.018	±.004	3/8	0.498	0.383	0.030	±.005
1/2	0.750	0.524	0.025	±.006	1/2	0.750	0.524	0.018	±.004	7/16	0.580	0.448	0.030	±.006
5/8	0.930	0.655	0.030	±.006	5/8	0.930	0.655	0.020	±.004	1/2	0.666	0.510	0.030	±.006
3/4	1.125	0.786	0.035	±.008	3/4	1.125	0.786	0.025	±.005	9/16	0.748	0.572	0.030	±.006
7/8	1.310	0.911	0.035	±.008	7/8	1.310	0.911	0.030	±.006	5/8	0.830	0.637	0.030	±.006
1	1.500	1.036	0.035	±.008	1	1.500	1.036	0.030	±.006	11/16	0.915	0.700	0.032	±.006
										3/4	1.000	0.764	0.040	±.007
										7/8	1.170	0.891	0.045	±.007
										1	1.330	1.020	0.050	±.008

### LIGHTWEIGHT WALL

Ordered as ID	Expanded I.D. Min.	Recovered I.D. Max.	Recovered Wall Thickness	
			Nom.	Tol.
1/8	0.215	0.130	0.008	±.002
1/4	0.410	0.260	0.010	±.003
5/16	0.470	0.329	0.012	±.003

AS 23053/12 product available upon request.

PACKAGING: Standard 4ft lengths, unless otherwise specified. Custom colors available on request.

Colors for AS23053/12 product produced in accordance with MIL-STD-104 available upon request.





WWW.ZEUSINC.COM

# PTFE Heat Shrink

## 2 to 1 Shrink Ratio

Approximate Ratio of Expanded I.D. to Recovered I.D. – Fractional Inch Sizes

HEAT SHRINKABLE EXTRUSIONS



### Metric Dimensions (mm)

STANDARD WALL					THIN WALL					INDUSTRIAL WALL				
Ordered as ID	Expanded I.D. Min.	Recovered I.D. Max.	Recovered Wall Thickness		Ordered as ID	Expanded I.D. Min.	Recovered I.D. Max.	Recovered Wall Thickness		Ordered as ID	Expanded I.D. Min.	Recovered I.D. Max.	Recovered Wall Thickness	
			Nom.	Tol.				Nom.	Tol.				Nom.	Tol.
1/8	5.46	3.30	0.51	±.10	1/8	5.46	3.30	0.38	±.08	1/8	4.22	3.30	0.76	±.13
1/4	10.41	6.60	0.51	±.10	1/4	10.41	6.60	0.38	±.08	3/16	6.35	4.90	0.76	±.13
5/16	11.94	8.36	0.51	±.10	5/16	11.94	8.36	0.38	±.08	1/4	8.46	6.53	0.76	±.13
3/8	14.22	10.13	0.64	±.15	3/8	14.22	10.13	0.38	±.08	5/16	10.54	8.13	0.76	±.13
7/16	16.64	11.73	0.64	±.15	7/16	16.64	11.73	0.46	±.10	3/8	12.65	9.73	0.76	±.13
1/2	19.05	13.31	0.64	±.15	1/2	19.05	13.31	0.46	±.10	7/16	14.73	11.38	0.76	±.15
5/8	23.62	16.64	0.76	±.15	5/8	23.62	16.64	0.51	±.10	1/2	16.92	12.95	0.76	±.15
3/4	28.58	19.96	0.89	±.20	3/4	28.58	19.96	0.64	±.13	9/16	19.00	14.53	0.76	±.15
7/8	33.27	23.14	0.89	±.20	7/8	33.27	23.14	0.76	±.15	5/8	21.08	16.18	0.76	±.15
1	38.10	26.31	0.89	±.20	1	38.10	26.31	0.76	±.15	11/16	23.24	17.78	0.81	±.15
										3/4	25.40	19.41	1.02	±.18
										7/8	29.72	22.63	1.14	±.18
										1	33.78	25.91	1.27	±.20

LIGHTWEIGHT WALL				
Ordered as ID	Expanded I.D. Min.	Recovered I.D. Max.	Recovered Wall Thickness	
			Nom.	Tol.
1/8	5.46	3.30	0.20	±.05
1/4	10.41	6.60	0.25	±.07
5/16	11.94	8.36	0.30	±.07

AS 23053/12 product available upon request.

PACKAGING: Standard 4ft lengths, unless otherwise specified. Custom colors available on request.

Colors for AS23053/12 product produced in accordance with MIL-STD-104 available upon request.



# PTFE Heat Shrink

## 4 to 1 Shrink Ratio

Approximate Ratio of Expanded I.D. to Recovered I.D. – Fractional Inch Sizes

WWW.ZEUSINC.COM

HEAT SHRINKABLE EXTRUSIONS



### Dimensions (inches)

Ordered As Fractional I.D.	Expanded I.D.	RECOVERED – AFTER HEAT SHRINK		
		I.D. Max.	Wall Thickness Nom.	Wall Thickness Tol.
5/64	0.078	0.025	0.009	±.002
1/8	0.125	0.037	0.012	±.002
3/16	0.187	0.050	0.012	±.002
1/4	0.250	0.063	0.012	±.002
5/16	0.312	0.078	0.012	±.002
3/8	0.375	0.096	0.012	±.002
7/16	0.438	0.112	0.012	±.002
1/2	0.500	0.144	0.015	±.004
9/16	0.562	0.155	0.015	±.004
5/8	0.625	0.178	0.015	±.004
11/16	0.687	0.198	0.015	±.004
3/4	0.750	0.224	0.015	±.004
7/8	0.875	0.244	0.015	±.004
1	1.000	0.278	0.015	±.004
1-1/4	1.250	0.347	0.015	±.004
1-1/2	1.500	0.400	0.015	±.004
1-3/4	1.750	0.450	0.015	±.004
2	2.000	0.520	0.020	±.005
2-1/4	2.250	0.585	0.020	±.005
2-1/2	2.500	0.650	0.020	±.005
2-3/4	2.750	0.710	0.020	±.005
3	3.000	0.775	0.020	±.005
3-1/4	3.250	0.835	0.020	±.005
3-1/2	3.500	0.900	0.025	±.005
3-3/4	3.750	0.960	0.025	±.005
4	4.000	1.025	0.025	±.005

### Metric Dimensions (mm)

Ordered As Fractional I.D.	Expanded I.D.	RECOVERED – AFTER HEAT SHRINK		
		I.D. Max.	Wall Thickness Nom.	Wall Thickness Tol.
5/64	1.98	0.64	0.23	±.05
1/8	3.18	0.94	0.31	±.05
3/16	4.75	1.27	0.31	±.05
1/4	6.35	1.60	0.31	±.05
5/16	7.92	1.98	0.31	±.05
3/8	9.53	2.44	0.31	±.05
7/16	11.13	2.84	0.31	±.05
1/2	12.70	3.66	0.38	±.10
9/16	14.27	3.94	0.38	±.10
5/8	15.88	4.52	0.38	±.10
11/16	17.45	5.03	0.38	±.10
3/4	19.05	5.69	0.38	±.10
7/8	22.23	6.20	0.38	±.10
1	25.40	7.06	0.38	±.10
1-1/4	31.75	8.81	0.38	±.10
1-1/2	38.10	10.16	0.38	±.10
1-3/4	44.45	11.43	0.38	±.10
2	50.80	13.21	0.51	±.13
2-1/4	57.15	14.86	0.51	±.13
2-1/2	63.50	16.51	0.51	±.13
2-3/4	69.85	18.03	0.51	±.13
3	76.20	19.68	0.51	±.13
3-1/4	82.50	21.21	0.51	±.13
3-1/2	88.90	22.86	0.64	±.13
3-3/4	92.95	24.38	0.64	±.13
4	101.60	26.03	0.64	±.13

AS 23053/12 product available upon request.

PACKAGING: Standard 4ft lengths, unless otherwise specified. Custom colors available on request.

Colors for AS23053/12 product produced in accordance with MIL-STD-104 available upon request.



# FEP Heat Shrink

## 1.3 to 1 Shrink Ratio

Approximate Ratio of Expanded I.D. to Recovered I.D. – AWG/Fractional Inch Sizes

WWW.ZEUSINC.COM

HEAT SHRINKABLE EXTRUSIONS

### Dimensions (inches)



Ordered as AWG Size	As Supplied Inside Diameter Min.	RECOVERED – AFTER HEAT SHRINK			
		I.D. Will Shrink to at Least	Min.	Wall Thickness Nom.	Max.
24	0.031	0.027	0.006	0.008	0.010
22	0.036	0.032	0.006	0.008	0.010
20	0.045	0.039	0.006	0.008	0.010
18	0.060	0.049	0.006	0.008	0.010
16	0.075	0.061	0.007	0.009	0.011
14	0.092	0.072	0.007	0.009	0.011
12	0.115	0.089	0.007	0.009	0.011
10	0.141	0.114	0.007	0.010	0.013
9	0.158	0.124	0.007	0.010	0.013
8	0.180	0.143	0.007	0.010	0.013
7	0.197	0.158	0.007	0.011	0.015
6	0.225	0.180	0.007	0.011	0.015
5	0.248	0.198	0.007	0.011	0.015
4	0.290	0.226	0.007	0.011	0.015
3	0.310	0.249	0.007	0.011	0.015
2	0.365	0.280	0.008	0.012	0.016
1	0.400	0.311	0.008	0.012	0.016
0	0.440	0.349	0.008	0.012	0.016

### Fractional Inch (decimal) Tubing

Size	As Supplied Inside Diameter Min.	RECOVERED – AFTER HEAT SHRINK			
		I.D. Will Shrink to at Least	Min.	Wall Thickness Nom.	Max.
3/8 (0.375)	0.500	0.383	0.011	0.015	0.019
7/16 (0.438)	0.580	0.448	0.016	0.020	0.024
1/2 (0.500)	0.666	0.510	0.016	0.020	0.024
5/8 (0.625)	0.830	0.637	0.021	0.025	0.029
3/4 (0.750)	1.000	0.764	0.026	0.030	0.034
7/8 (0.875)	1.170	0.891	0.031	0.035	0.039
1 (1.000)	1.330	1.020	0.031	0.035	0.039
1-1/8 (1.125)	1.500	1.145	0.031	0.035	0.039
1-1/4 (1.250)	1.666	1.270	0.031	0.035	0.039
1-3/8 (1.375)	1.833	1.390	0.031	0.035	0.039
1-1/2 (1.500)	2.000	1.570	0.031	0.035	0.039

AS 23053/11 product available upon request.

COLOR: Supplied in natural unless otherwise specified. Custom colors available on request. Colors for 23053/11 product produced in accordance with MIL-STD-104 available upon request.

CUSTOM SPECIFICATIONS AND TOLERANCES QUOTED UPON REQUEST





WWW.ZEUSINC.COM

# FEP Heat Shrink

## 1.3 to 1 Shrink Ratio

Approximate Ratio of Expanded I.D. to Recovered I.D. – AWG/Fractional Inch Sizes

HEAT SHRINKABLE EXTRUSIONS



### Metric Dimensions (mm)

Ordered as AWG Size	As Supplied Inside Diameter Min.	RECOVERED – AFTER HEAT SHRINK			
		I.D. Will Shrink to at Least	Min.	Wall Thickness Nom.	Max.
24	0.79	0.69	0.15	0.20	0.25
22	0.91	0.81	0.15	0.20	0.25
20	1.14	0.99	0.15	0.20	0.25
18	1.52	1.25	0.15	0.20	0.25
16	1.91	1.55	0.18	0.23	0.28
14	2.34	1.83	0.18	0.23	0.28
12	2.92	2.26	0.18	0.23	0.28
10	3.58	2.90	0.18	0.25	0.33
9	4.01	3.15	0.18	0.25	0.33
8	4.57	3.63	0.18	0.25	0.33
7	5.00	4.01	0.18	0.28	0.38
6	5.72	4.57	0.18	0.28	0.38
5	6.30	5.03	0.18	0.28	0.38
4	7.37	5.74	0.18	0.28	0.38
3	7.87	6.32	0.18	0.28	0.38
2	9.27	7.11	0.20	0.30	0.41
1	10.16	7.90	0.20	0.30	0.41
0	11.18	8.86	0.20	0.30	0.41

### Fractional Inch (mm) Tubing

Size	As Supplied Inside Diameter Min.	RECOVERED – AFTER HEAT SHRINK			
		I.D. Will Shrink to at Least	Min.	Wall Thickness Nom.	Max.
3/8 (9.53)	12.70	9.73	0.28	0.38	0.48
7/16 (11.13)	14.73	11.38	0.41	0.51	0.61
1/2 (12.70)	16.92	12.95	0.41	0.51	0.61
5/8 (15.88)	21.08	16.18	0.53	0.64	0.74
3/4 (19.05)	25.40	19.41	0.66	0.76	0.86
7/8 (22.23)	29.72	22.63	0.79	0.89	0.99
1 (25.40)	33.78	25.91	0.79	0.89	0.99
1-1/8 (28.58)	38.10	29.08	0.79	0.89	0.99
1-1/4 (31.75)	42.32	32.26	0.79	0.89	0.99
1-3/8 (34.93)	46.56	35.31	0.79	0.89	0.99
1-1/2 (38.10)	50.80	39.88	0.79	0.89	0.99

AS 23053/11 product available upon request.

COLOR: Supplied in natural unless otherwise specified. Custom colors available on request. Colors for 23053/11 product produced in accordance with MIL-STD-104 available upon request.

CUSTOM SPECIFICATIONS AND TOLERANCES QUOTED UPON REQUEST



WWW.ZEUSINC.COM

# FEP Heat Shrink

## 1.6 to 1 Shrink Ratio

HEAT SHRINKABLE EXTRUSIONS



### Dimensions (inches)

Fractional	Size		Expanded I.D. Minimum	Recovered I.D. Maximum	Wall Thickness	
	Decimal				Nom.	Tol.
3/32		0.093	0.093	0.056	0.008	±0.003
1/8		0.125	0.125	0.075	0.010	±0.003
3/16		0.188	0.188	0.115	0.010	±0.003
1/4		0.250	0.250	0.150	0.010	±0.003
3/8		0.375	0.375	0.225	0.012	±0.003
1/2		0.500	0.500	0.300	0.015	±0.004
3/4		0.750	0.750	0.450	0.020	±0.004
1		1.000	1.000	0.600	0.025	±0.005
1-1/2		1.500	1.500	0.900	0.030	±0.005
2		2.000	2.000	1.200	0.030	±0.005

### Metric Dimensions (mm)

Fractional	Size		Expanded I.D. Minimum	Recovered I.D. Maximum	Wall Thickness	
	mm				Nom.	Tol.
3/32		2.36	2.36	1.42	0.20	±0.08
1/8		3.18	3.18	1.91	0.25	±0.08
3/16		4.78	4.78	2.92	0.25	±0.08
1/4		6.35	6.35	3.81	0.25	±0.08
3/8		9.53	9.53	5.72	0.31	±0.08
1/2		12.70	12.70	7.62	0.38	±0.10
3/4		19.05	19.05	11.43	0.51	±0.10
1		25.40	25.40	15.24	0.64	±0.13
1-1/2		38.10	38.10	22.86	0.76	±0.13
2		50.80	50.80	30.48	0.76	±0.13

AS 23053/11 product available upon request.

COLOR: Supplied in natural unless otherwise specified. Custom colors available on request. Colors for 23053/11 product produced in accordance with MIL-STD-104 available upon request.

CUSTOM SPECIFICATIONS AND TOLERANCES QUOTED UPON REQUEST

Page Intentionally Left Blank





WWW.ZEUSINC.COM

# PTFE/FEP Dual-Shrink™ Tubing

HEAT SHRINKABLE EXTRUSIONS



## Heat Shrink Tubing Offering a Tight, Moisture-Resistant, Wear-Proof Encapsulation

- Outer tubing of PTFE shrinks for tight fit when heat is applied.
- Inner layer of FEP melts and flows to encapsulate parts.

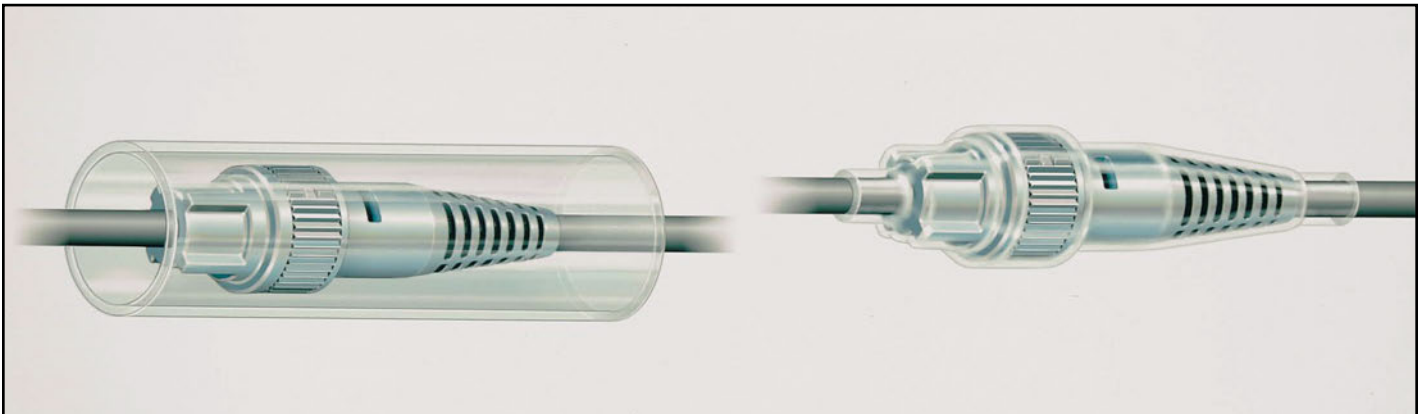

ZEUS Dual-Shrink™ tubing of fluoropolymer PTFE/FEP is constructed with an exterior of heat shrink PTFE and an inner layer of FEP. It is easy to apply, and is designed to provide a tight, moisture-proof bond over wires, cables, connectors, splices, terminals, etc. The PTFE shrinks tightly over inserted parts when the covered section is heated, while the FEP melts and flows into a solid or near-

solid encapsulation with a fit so tight that it can withstand the most severe stresses involving pull or vibration. ZEUS Dual-Shrink™ tubing provides all the outstanding electrical, chemical, and mechanical properties of PTFE including a service temperature up to 450°F/232°C. Custom specifications and tolerances quoted upon request.



# PTFE/FEP Dual-Shrink™ Tubing

WWW.ZEUSINC.COM

HEAT SHRINKABLE EXTRUSIONS



## Dimensions (inches)

STANDARD WALL				LIGHTWEIGHT WALL			
Item No.	As Supplied I.D. Min.	Recovered Dim. I.D. Will Shrink To at Least	After Shrinking Total Wall Thickness-Norm.	Item No.	As Supplied I.D. Min.	Recovered Dim. I.D. Will Shrink To at Least	After Shrinking Total Wall Thickness-Norm.
ZDS-S-036	0.036	0.000	N/A	ZDS-L-065	0.065	0.000	N/A
ZDS-S-060	0.060	0.000	N/A	ZDS-L-115	0.115	0.045	0.015
ZDS-S-130	0.130	0.000	N/A	ZDS-L-130	0.130	0.060	0.015
ZDS-S-160	0.160	0.000	N/A	ZDS-L-180	0.180	0.065	0.015
ZDS-S-190	0.190	0.062	0.035	ZDS-L-190	0.190	0.070	0.015
ZDS-S-250	0.250	0.125	0.035	ZDS-L-240	0.240	0.150	0.020
ZDS-S-350	0.350	0.190	0.035	ZDS-L-350	0.350	0.210	0.025
ZDS-S-450	0.450	0.312	0.055	ZDS-L-480	0.480	0.315	0.032
ZDS-S-700	0.700	0.440	0.055	ZDS-L-700	0.700	0.500	0.040
ZDS-S-950	0.950	0.630	0.065	ZDS-L-1000	1.000	0.700	0.045

## Metric Dimensions (mm)

STANDARD WALL				LIGHTWEIGHT WALL			
Item No.	As Supplied I.D. Min.	Recovered Dim. I.D. Will Shrink To at Least	After Shrinking Total Wall Thickness-Norm.	Item No.	As Supplied I.D. Min.	Recovered Dim. I.D. Will Shrink To at Least	After Shrinking Total Wall Thickness-Norm.
ZDS-S-036	0.91	0.000	N/A	ZDS-L-065	1.65	0.000	N/A
ZDS-S-060	1.52	0.000	N/A	ZDS-L-115	2.92	1.14	0.38
ZDS-S-130	3.30	0.000	N/A	ZDS-L-130	3.30	1.52	0.38
ZDS-S-160	4.06	0.000	N/A	ZDS-L-180	4.57	1.65	0.38
ZDS-S-190	4.83	1.57	0.89	ZDS-L-190	4.83	1.78	0.38
ZDS-S-250	6.35	3.18	0.89	ZDS-L-240	6.10	3.81	0.51
ZDS-S-350	8.89	4.83	0.89	ZDS-L-350	8.89	5.33	0.64
ZDS-S-450	11.43	7.92	1.40	ZDS-L-480	12.19	8.00	0.81
ZDS-S-700	17.78	11.18	1.40	ZDS-L-700	17.78	12.70	1.02
ZDS-S-950	24.13	16.00	1.65	ZDS-L-1000	25.40	17.78	1.14

**PACKAGING:** Standard 4ft lengths, unless otherwise specified.  
Custom colors available on request. Dual-Shrink™ Tubing is a ZEUS registered trademark.



# ZEUS<sup>®</sup>

SPECIALTY PRODUCTS



## SPECIALTY PRODUCTS







WWW.ZEUSINC.COM

# PTFE Sub-Lite-Wall™

## Extruded & Heat Shrinkable Tubing

All Sub-Lite-Wall™ is custom ordered

SPECIALTY PRODUCTS

### Dimensions (Inches)

EXTRUDED		HEAT SHRINK		
Inside Diameter Inches	Wall Thickness Inches	Expanded I.D. Min. Inches	Recovered I.D. Max. Inches	Recovered Wall Thickness Inches
0.0020	0.0020	0.020	0.008	0.0020
0.0025	0.0020	0.025	0.010	0.0020
0.0030	0.0020	0.030	0.012	0.0020
0.0040	0.0020	0.034	0.015	0.0020
0.0050	0.0030	0.038	0.018	0.0020
0.0060	0.0030	0.046	0.022	0.0020
0.0080	0.0030	0.050	0.027	0.0020
0.0100	0.0030	0.055	0.032	0.0020
0.0130	0.0030	0.060	0.039	0.0020
0.0160	0.0030	0.076	0.049	0.0020
0.0200	0.0020	0.093	0.061	0.0020
0.0250	0.0020	0.120	0.072	0.0020
0.0320	0.0020	0.150	0.089	0.0020
0.0400	0.0015	0.191	0.112	0.0020
0.0650	0.0015	0.240	0.141	0.0025
0.0730	0.0015			
0.0840	0.0015			
0.0980	0.0020			
0.1100	0.0020			
0.1620	0.0025			
0.2040	0.0035			
0.2580	0.0040			
0.3250	0.0050			

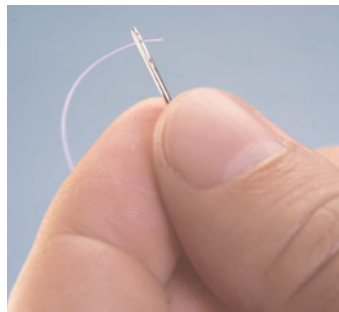

Now available in Sub-Lite-Wall™ configurations with wall thicknesses down to .001 on many sizes. +/- .0005" (.013mm). Tolerances available in most sizes.

ZEUS SUB-LITE-WALL™ Tubing is available in both regular extruded micro-miniature dimensions, and in heat shrink versions. Inside diameters, outside diameters, and wall thicknesses are uniform throughout. **The dimensions and tolerances shown here are only a guide.** You can write your own specifications with the assurance that ZEUS can meet your requirements completely in either extruded or heat shrink version.



WWW.ZEUSINC.COM

# PTFE Sub-Lite-Wall™ Extruded & Heat Shrinkable Tubing

All Sub-Lite-Wall™ is custom ordered

SPECIALTY PRODUCTS

## Metric Dimensions (mm)

EXTRUDED		HEAT SHRINK		
Inside Diameter (mm)	Wall Thickness (mm)	Expanded I.D. Min. (mm)	Recovered I.D. Max. (mm)	Recovered Wall Thickness
0.051	0.051	0.508	0.203	0.051
0.064	0.051	0.635	0.254	0.051
0.076	0.051	0.762	0.305	0.051
0.102	0.051	0.864	0.381	0.051
0.127	0.076	0.965	0.457	0.051
0.152	0.076	1.168	0.559	0.051
0.203	0.076	1.270	0.686	0.051
0.254	0.076	1.397	0.813	0.051
0.330	0.076	1.524	0.991	0.051
0.406	0.076	1.930	1.245	0.051
0.508	0.051	2.362	1.549	0.051
0.635	0.051	3.048	1.829	0.051
0.813	0.051	3.810	2.261	0.051
1.016	0.038	4.851	2.845	0.051
1.651	0.038	6.096	3.581	0.064
1.854	0.038			
2.134	0.038			
2.489	0.051			
2.794	0.051			
4.115	0.064			
5.182	0.089			
6.553	0.102			
8.255	0.127			

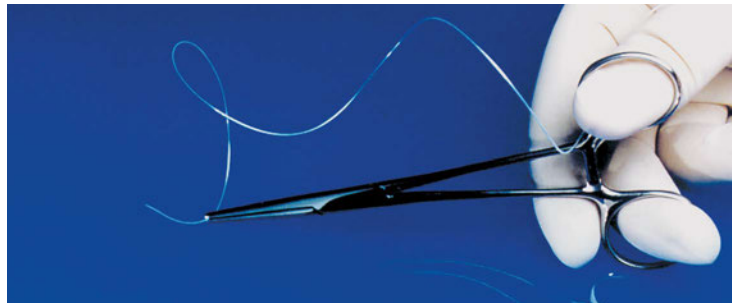

Now available in Sub-Lite-Wall™ configurations with wall thicknesses down to .001 on many sizes. +/- .0005" (.013mm.) Tolerances available in most sizes.

ZEUS SUB-LITE-WALL™ Tubing is available in both regular extruded micro-miniature dimensions, and in heat shrink versions. Inside diameters, outside diameters, and wall thicknesses are uniform throughout. **The dimensions and tolerances shown here are only a guide.** You can write your own specifications with the assurance that ZEUS can meet your requirements completely in either extruded or heat shrink version.



# PEEK™ Tubing

All PEEK™ is custom ordered

WWW.ZEUSINC.COM

SPECIALTY PRODUCTS

Now available in Sub-Lite-Wall™ configurations with wall thicknesses down to .002 on many sizes. +/- .001" (.025mm) tolerances available in most sizes. Call us for more details.

## Dimensions (Inches)

I.D.	O.D.	Pressure Rating*
0.003	0.020	2000 psi
0.005	0.020	2000 psi
0.010	0.020	2000 psi
0.003	0.062	5000 psi
0.005	0.062	5000 psi
0.007	0.062	5000 psi
0.010	0.062	5000 psi
0.020	0.062	5000 psi
0.030	0.062	5000 psi
0.040	0.062	5000 psi
0.055	0.062	5000 psi
0.062	0.125	5000 psi
0.080	0.125	3000 psi

The dimensions and tolerances shown here are only a guide.

## Metric Dimensions (mm)

I.D.	O.D.	Pressure Rating*
0.076	.508	2000 psi
0.127	.508	2000 psi
0.254	.508	2000 psi
0.076	1.575	5000 psi
0.127	1.575	5000 psi
0.178	1.575	5000 psi
0.254	1.575	5000 psi
0.508	1.575	5000 psi
0.762	1.575	5000 psi
1.016	1.575	5000 psi
1.397	1.575	5000 psi
1.575	3.175	5000 psi
2.032	3.175	3000 psi

\* Suggested maximum safe operating pressure



WWW.ZEUSINC.COM

# PEEKshrink™

## Heat-Shrinkable Tubing for Challenging Environments

All PEEKshrink™ is Custom Ordered

SPECIALTY PRODUCTS

### Features:

- Continuous service temperature 500°F/260°C
- Translucent recovery shrink temperature 572°F - 644°F (300°C - 340°C)
- Opaque recovery shrink temperature 680°F - 725°F (360°C - 385°C)
- Recovered wall range of 0.003" to 0.018" (0.076 to 0.457 mm)

### Benefits:

- Excellent abrasion resistance
- Extends life of the protected item
- Adhesion to metals
- Available in colors

### Applications:

- Electrical component covering
- Protective jacketing
- Wire Splicing
- Reusable medical devices

### Technical Notes:

- Zeus will assist in developing custom heatshrink processes
- Class VI approved resins available

## PEEKshrink™ 1.4:1 Heat Shrinkable AWG Tubing

Zeus P/N	Ordered as AWG Size	As Supplied Inside Diameter Min	Recovered Dimension After Shrinking Wall Thickness			
			Recovered ID Max	Minimum	Nominal	Maximum
85322	17	0.038	0.027	0.005	0.007	0.009
85318	16	0.045	0.032	0.005	0.007	0.009
85184	15	0.055	0.039	0.005	0.007	0.009
85204	14	0.085	0.060	0.005	0.007	0.009
85197	13	0.092	0.065	0.005	0.007	0.009
85189	12	0.101	0.072	0.005	0.007	0.009
85313	11	0.112	0.080	0.005	0.007	0.009
85310	10	0.125	0.089	0.005	0.007	0.009
85298	9	0.137	0.098	0.005	0.007	0.009
85294	8	0.160	0.114	0.005	0.007	0.009
85146	7	0.174	0.124	0.005	0.007	0.009
85063	6	0.200	0.143	0.005	0.007	0.009
85213	5	0.221	0.158	0.005	0.007	0.009
85236	4	0.252	0.180	0.005	0.007	0.009
85243	3	0.277	0.198	0.005	0.007	0.009
85246	2	0.316	0.226	0.005	0.007	0.009
85255	1	0.349	0.249	0.005	0.007	0.009
85326	0	0.392	0.280	0.005	0.007	0.009

**PACKAGING:** Standard 4ft lengths. Custom sizes and lengths available upon request.

### PEEKshrink™ Tubing Properties

Properties	ASTM	Units	
Tensile Modulus	D638	KSI	1,309
Tensile Stress at Yield	D638	PSI	14,503
Glass Transition Temp	D3418	°F/°C	321/161
Dielectric Strength	D149	V/mil	3570
Thermal Endurance	NEMA MW 1000	°F/°C	752/400
Crystallinity	D3814	%	40

Tubing performance and characteristics may change based on tubing size.





WWW.ZEUSINC.COM

# PEEK™ Insulated Wire

## Insulated Copper Wire for Challenging Environments

SPECIALTY PRODUCTS

### Feature/Capabilities:

- 100% AC spark tested during extrusion
- Round, square & rectangular profiles available
- Various types of wire available, including silver and nickel plated wire as well as custom wire types

### Key Properties:

- High continuous operating temperature 500°F/260°C
- Outstanding abrasion resistance
- Excellent dielectric strength
- Exceptional chemical resistance
- Protects against corrosion

Size (AWG)	Nominal Bare Copper Diameter	
	in.	mm
3	0.2294	5.8268
4	0.2043	5.1892
5	0.1819	4.6203
6	0.1620	4.1148
7	0.1443	3.6652
8	0.1285	3.2639
9	0.1144	2.9058
10	0.1019	2.5883
11	0.0907	2.3038
12	0.0808	2.0523
13	0.0720	1.8288
14	0.0641	1.6281
15	0.0571	1.4503
16	0.0508	1.2903
17	0.0453	1.1506
18	0.0403	1.0236
19	0.0359	0.9119
20	0.0320	0.8128
21	0.0285	0.7239
22	0.0253	0.6426
23	0.0226	0.5740
24	0.0201	0.5105
25	0.0179	0.4547
26	0.0159	0.4039
27	0.0142	0.3607
28	0.0126	0.3200
29	0.0113	0.2870
30	0.0100	0.2540
31	0.0089	0.2261
32	0.0080	0.2032
33	0.0071	0.1803
34	0.0063	0.1600
35	0.0056	0.1422
36	0.0050	0.1270
37	0.0045	0.1143
38	0.0040	0.1016
39	0.0035	0.0889
40	0.0031	0.0787

\*All PEEK Insulated Wire is custom ordered. Wall thicknesses available from 0.001" - 0.026" (0.025mm - 0.660mm) depending on the conductor size.



WWW.ZEUSINC.COM

# Special Shapes

All Special Shapes are custom ordered

SPECIALTY PRODUCTS



**Multi-Lumens:** Unique extrusions providing multiple lumens or passages. All multi-lumens are custom designed in different resins including but not limited to: PTFE, ePTFE, FEP, PFA, PEEK™ and more. Design configurations are unlimited and are specific to your needs with all aspects kept confidentially to each customer.

## A multitude of Multi-Lumen advantages

- Highly flexible
- Impervious to most corrosives
- Inert • Non-toxic
- Heat resistant to 500°F
- Superior lubricity
- Class VI approved resins available
- Reliable fluid transfer
- High dielectric strength

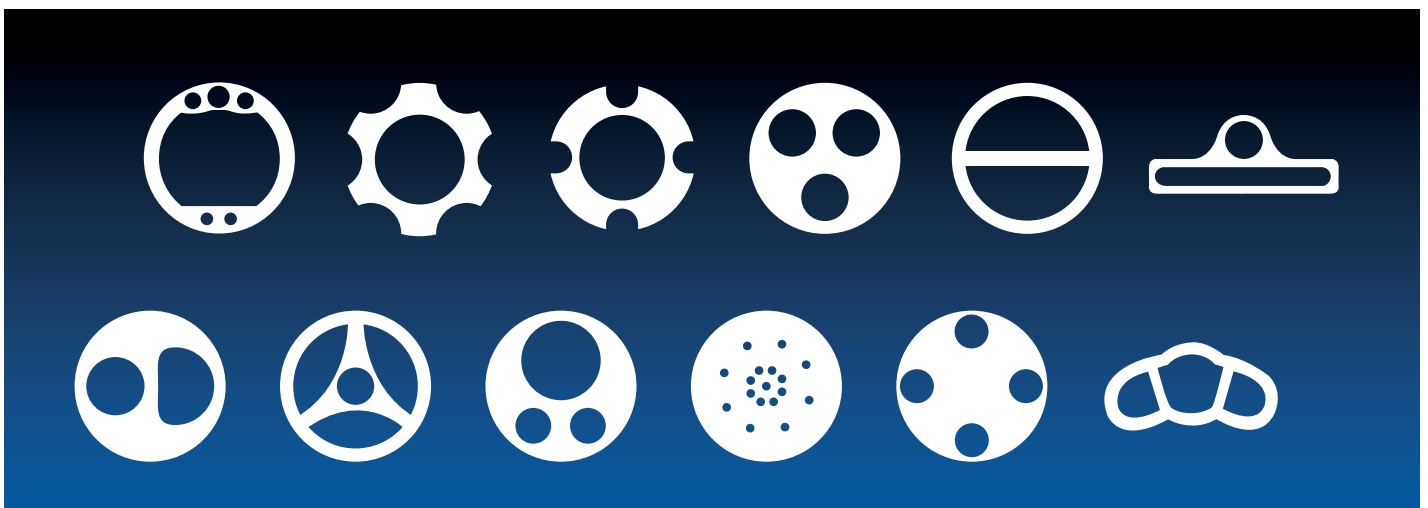



WWW.ZEUSINC.COM

# Performance Fiber

SPECIALTY PRODUCTS

ZEUS offers an arsenal of fibers designed to perform in diverse and demanding applications. Properties such as high tensile strength, optical clarity, and extreme chemical and temperature resistance define Zeus fiber. These lightweight monofilaments also have superior friction and wear properties, and are ideal for use in abrasive environments. Our standard product offering ranges in size from .003" - .040" and includes fibers made from PEEK, PFA, FEP, ETFE, PVDF and ECTFE. Other resins and customized products are available upon request.

Capitalizing on more than 45+ years of polymer experience, ZEUS continues to provide superior products with the highest standards of quality and control. Whether it's braided for a wiring harness, woven for a filter, or chopped for composites, ZEUS fibers excel in the most demanding environments and applications.

### PEEK Fiber

High tensile strength  
Abrasion resistant  
Lightweight material

### FEP Fiber

Very robust  
Luminous transmittance of 96%  
Excellent lubricity

### ECTFE (Halar) Fiber

Impact and temperature resistant  
Superior surface smoothness  
Excellent value

### PFA Fiber

Superior purity  
Chemical resistant  
Long service life

### ETFE (Tefzel) Fiber

Superior mechanical toughness  
Chemical inertness  
Radiation resistant

### PVDF Fiber

UV stability  
Mechanically tough  
Abrasion resistant

## PEEK Fiber Specifications (Natural or Black)

Specification	0.010" Diameter	0.011" Diameter	0.016" Diameter
OD Tolerance	± 0.0015"	± 0.0015"	± 0.0015"
Min Tensile Strength	4 lbs	5.5 lbs	11 lbs
Min Elongation @ Break	18 %	18 %	20 %
Max Elongation @ Break	30 %	30 %	35 %
Min Shrinkage	3 %	3 %	2 %
Max Shrinkage	5 %	5 %	6 %

Properties based on standard Zeus PEEK Fiber. Custom colors, diameters, and properties available.



WWW.ZEUSINC.COM

# Lay-Flat Tubing

SPECIALTY PRODUCTS



## FEP, PEEK, PE and EVA

Dedicated to fulfilling the changes in the markets our customers serve, ZEUS is pleased to offer lay-flat tubing. Lay-flat tubing was traditionally designed to meet the needs for ultra-thin walls in the lighting and roller industries but now has applications in many medical and industrial markets. Lay-flat tubing made of high quality polymers offer strength, lubricity, and chemical inertness.

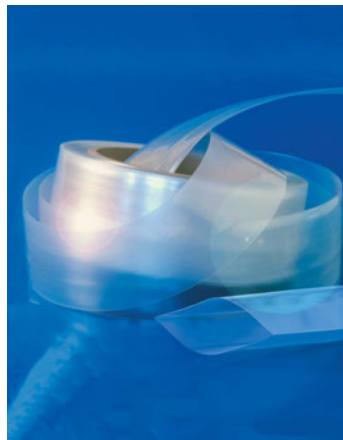

**COLOR:** Natural. Custom colors available upon request.

## FEP, PEEK and PE

- Wall Sizes: .004" to .008"
- ID Ranges: .250" to 3.180"
- Lay Flat Widths: .400" to 5.000"
- H/S: Expansion ratios up to 2:1 when applicable
- Put Up: Spooled or cut to length

ZEUS specializes in made-to-order sizes designed for your unique application.







WWW.ZEUSINC.COM

# Dual Tube™

SPECIALTY PRODUCTS



ZEUS Dual Tube™ is a superior, easy handling fluoropolymer tubing typically used for water monitoring and other applications. It is produced as a single unit of two independent tubes of similar or variable sizes that stay together until separation is required.



Once separated the surface of each tube is smooth and contains no flaws, flat spots, ridges, or other defects that can interfere with sealing.

ZEUS Dual Tube™ is supplied in smooth tangle-free, easy-to-handle, extra long lengths that are tough, durable and chemically inert so that sample properties cannot be affected. Long-term exposure to contaminants cannot impair performance, and it is simple to clean and reuse. Samples obtained remain pure and free of mineral and organic sediments. ZEUS Dual Tubes

can be manufactured from PTFE, FEP, Polyethylene and other resins in a variety of configurations.

- Makes monitoring accurate & effective
- Insures consistent sampling results
- Superior reliability
- Non-contaminating
- Protects integrity of sample & well water

ZEUS also has a complete line of **FEP-Lined Polyethylene** (and other resins) tubing developed specifically for the high purity requirements of the environmental monitoring industries. Contact one of our Technical Representatives for more details on this unique product and how it can be beneficial to your application.



## Dimensions (inches)

1/2" OD x 3/8" ID	and	1/2" OD x 3/8" ID
3/8" OD x 1/4" ID	and	1/4" OD x 1/8" ID
1/4" OD x 1/8" ID	and	1/4" OD x 1/8" ID
1/2" OD x 3/8" ID	and	3/8" OD x 1/4" ID
1/2" OD x 3/8" ID	and	1/4" OD x 1/8" ID
3/8" OD x 1/4" ID	and	3/8" OD x 1/4" ID

## Metric Dimensions (mm)

12.70 OD x 9.53 ID	and	12.70 OD x 9.53 ID
9.53 OD x 6.35 ID	and	6.35 OD x 3.18 ID
6.35 OD x 3.18 ID	and	6.35 OD x 3.18 ID
12.70 OD x 9.53 ID	and	9.53 OD x 6.35 ID
12.70 OD x 9.53 ID	and	6.35 OD x 3.18 ID
9.53 OD x 6.35 ID	and	9.53 OD x 6.35 ID

Supplied in a variety of ODs and IDs  
Other custom sizes and combinations quoted on request



WWW.ZEUSINC.COM

# Splines

## Wires, Cables, Coaxial Cores

# Snaptube™

SPECIALTY PRODUCTS

Custom Sizes Available

## Splines

ZEUS can provide custom splined extrusions over wire for the coaxial cable manufacturer. With tight tolerances, custom lengths and unique wire cores. All extrusions are done to customer specifications.

## Wire, Cables, Coaxial Cores

These extrusions are special and unique because of tolerances, concentricity, finish, lengths and many other considerations. New and unexplored avenues of applications become a reality due to the unmatched capabilities of Zeus' extrusion processes.

- Withstands continuous temperatures to 500°F with PTFE
- Outstanding concentricity
- Shockproof
- Abrasion proof
- Moisture proof

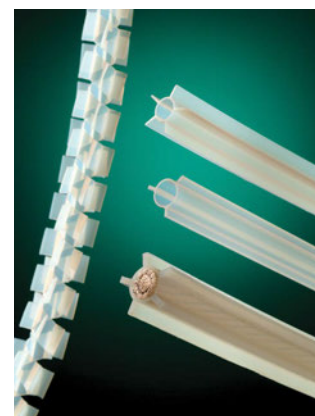

## Snaptube™ Restores Damaged Conductors

### Dimensions (inches)

Item No.	Nominal I.D.	Nominal Wall Thickness	Recommended Bundle Dia. Max.
ZST-I-250	1/4	.030	.200
ZST-I-437	7/16	.030	.400
ZST-I-562	9/16	.030	.500
ZST-I-625	5/8	.035	.600
ZST-I-812	1 3/16	.035	.750
ZST-I-1000	1	.040	.975
ZST-I-1375	1 3/8	.045	1.350

### Metric Dimensions (mm)

Item No.	Nominal I.D.	Nominal Wall Thickness	Recommended Bundle Dia. Max.
ZST-I-250	6.35	.76	5.08
ZST-I-437	11.11	.76	10.16
ZST-I-562	14.29	.76	12.70
ZST-I-625	15.88	.89	15.24
ZST-I-812	20.64	.89	19.05
ZST-I-1000	25.40	1.02	24.77
ZST-I-1375	34.93	1.14	34.29

**STANDARD LENGTHS:** 5-foot and 10-foot

**CUSTOM SIZES:** Other lengths, and smaller or larger diameters quoted on request.

**COLOR:** Natural. Other colors are available per MIL-STD-104 and quoted upon request.

SNAPTUBE™ is a trademark of ZEUS Industrial Products, Inc.

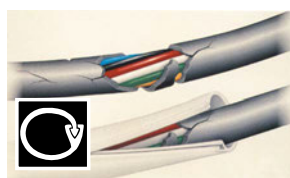



WWW.ZEUSINC.COM

# Absorv™ Bioabsorbable Polymers

SPECIALTY PRODUCTS



Zeus is able to process bioabsorbable polymers into virtually any form including tubes, monofilament, sheets, and microporous non-wovens. We are able to extrude bioabsorbable resins into high precision tubular geometries and perform full polymer characterization, providing necessary data to meet regulatory requirements.

Capabilities include tight tolerance extrusion, unique formulations, customization, sophisticated materials science, and tailored degradation profiles. Zeus is able to assist customers with material selection and testing, as well as evaluate possible processing and product forms that are not currently part of its standard offering.

## Key Properties

- Modulated degradation rates
- Varying strengths and hardness
- Multiple extrusion forms
- FDA-approved for medical devices
- Tailored to customers' specifications

## ZEUS Capabilities

- Tight tolerance extrusion
- Sophisticated materials science
- Advanced processing and development
- Multiple combinations of the product

Material	T <sub>g</sub> (C)	T <sub>m</sub> (C)	E (Gpa)	σ (MPa)	Mass Loss (months)*
PLLA	60	180 - 190	3.0 - 4.0	65	18 - 36
PGA	40	215 - 225	6.0 - 7.0	95	4 - 6
PDLLA	55	amorph	1.0 - 3.0	40	12 - 16
PCL	-60	55 - 65	0.2 - 0.4	25	24 - 36
PLGA (85L/15G)	55	140 - 150	2.0 - 4.0	65	12 - 18
PLGA (82L/18G)	50	135 - 145	2.0 - 4.0	60	12 - 16
PLGA (10L/90G)	42	202 - 210	3.0 - 6.0	45	3 - 4
PDLGA (50DL/50G)	45	amorph	2.0 - 4.0	45	1 - 2
PLDLA (80L/20DL)	60	115 - 130	2.0 - 4.0	50	12 - 18
PLC (70L/30C)	20	105 - 115	0.02 - 0.04	3	12 - 24

\*Approximate values for a small selection of absorbable materials processed by Zeus



WWW.ZEUSINC.COM

# Aeos™ ePTFE Tubing and Monofilament

SPECIALTY PRODUCTS



ePTFE tubing from ZEUS is made by expanding PTFE tubing, under controlled conditions, during the manufacturing process. This process alters the physical properties of the tubing by creating microscopic pores in the structure of the material. The resulting tubing is imparted with unique physical properties that make it ideal for use in medical devices, electronic insulators, and a host of other applications.



- Excellent UV resistance
- Certified USP Class VI resin
- Low coefficient of friction
- Watertight (low pressure)
- Hydrophobic/hydrophilic

## ZEUS ePTFE Capabilities

Through extensive investments in R&D, ZEUS has developed a wide range of ePTFE processing capabilities. This broad control over the manufacturing process allows ZEUS to manipulate the physical and mechanical properties of the material. The dimensions of the tubing, as well as the ID and porosity ranges, can be designed to match your proprietary specifications.

## Key Properties

ePTFE differs from regular PTFE tubing in that the material is microporous, soft, very flexible, has a lower dielectric constant, increased linear strength, and improved biocompatibility.

- Microporous
- Air permeable
- Soft and flexible
- Biocompatible
- High linear strength
- Chemically inert
- Low dielectric constant ■

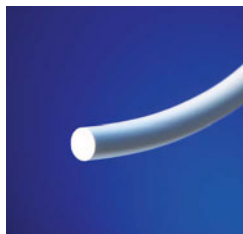

Excellent radial expansion

- Tubing:  
ID Range = 0.005" – 1.250"  
Wall Range = 0.002" – 0.100"
- Monofilament  
OD Range = 0.007" – 0.150"
- ePTFE Multi-Lumen
- Variable porosity
- Long continuous lengths available
- Custom material properties
- Chemical impregnation
- Custom colors





WWW.ZEUSINC.COM

# Aeos™ ePTFE Tubing and Monofilament

SPECIALTY PRODUCTS



## Zeus Support

For over 55+ years, ZEUS has assisted medical device engineers in bringing their concepts and ideas to reality. Today, we work closely with numerous manufacturers to confidentially assist them in the development of new products and technology.

- Test reports
- Technical sales staff
- SEM analysis
- R&D engineering support
- Special certs
- Custom packaging
- Product development
- Medical grade inspection
- Confidential support



excel in applications requiring cellular ingrowth. ePTFE is well known in medical research papers for its endothelization and thrombogenic properties. PTFE resin has long been utilized for implantable medical devices due to its biocompatibility and

## Biocompatibility

The structure of ePTFE is unique in that the material is made up of a number of solid nodes inter-connected by a matrix of thin fibrils. The spacing between the nodes (IND) is what allows the material to





# ZEUS<sup>®</sup>



**VALUE  
ADDED  
SERVICES**



VALUE ADDED SERVICES



# Value Added Services

VALUE ADDED SERVICES

## The Benefits of ZEUS Value Added Services and Operations

In response to requests from our customers and our inherent knowledge of our product, ZEUS has developed extensive experience in performing a variety of secondary operations and valued added services that allow you to focus on your core processes.



By having ZEUS perform secondary or value added operations, our customers have recognized increased economies of scale, improved yields, and increased manufacturing efficiencies.

### ***Our Value Added operations for our customers have proven to:***

- Provide solutions for customers who cannot perform secondary applications in-house
- Reduce labor costs and time
- Improve efficiency
- Reduce material cost (economies of scale)
- Reduce scrap and waste
- Reduce capital expenditure
- Laser-Marking, Pad-Printing, Drawn Fibers

- Reduce need for prototyping because of our high familiarity with tubing
- Increase yields
- Increase gross profits
- Reduce lead time to end user
- Reduce overhead costs

## Bump/Draw-down

Utilizing various manufacturing and secondary processes, ZEUS has developed the technology to vary the ID and OD of tubing along the length of the extrusion. Often referred to as "Bump Tubing", "Draw-downs", or "Bubble Tubing", this technology allows for unique design solutions. Some applications for this technology utilize the variability in dimensions for the attachment of fittings and parts as well as adjustments in flexibility.



- Tight tolerances
- Available in thermoplastics and PTFE
- Variable transition lengths
- ID or OD may be modified





WWW.ZEUSINC.COM

# Value Added Services

VALUE ADDED SERVICES

## Custom Cutting

- Tight tolerances available
- Ability to control ovality
- In-line cutting
- Clean, crisp cuts
- Angle cuts on one/both ends available

## Custom Packaging & Labeling

- ZEUS has ability to print labels and bar codes to customer's specifications.
- Ability to package and apply label/bar code using customer supplied materials which reduces/eliminates customers need to repackage
- Blank-package materials for distributors
- Custom packaging to customers specifications available



## Drilling

- Custom, clean and burr-free holes
- Single and multiple hole configurations available
- High-speed automation capability



## Etching

- Improves the bondability of tubing without affecting mechanical properties
- Can be done over the length of the tube or for specific lengths on the end
- Extrusions can be etched on the ID, OD or tip
- Additional details available in the Technical Information section

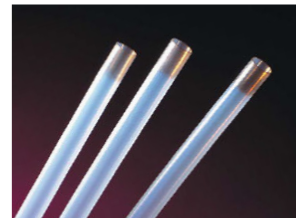

### Applications include:

- Insulator for fiber optic cable
- Roller covers
- Medical devices
- Anywhere bonding is required

## Flaring & Flanging

Flaring and flanging is often used to facilitate the attachment of tubing to fittings or to allow for ease of insertion of items into the inside of the tube.



ZEUS' expertise in manufacturing fluoropolymer tubing has lead to the development of unique capabilities for flaring and flanging tubing. Through an





WWW.ZEUSINC.COM

# Value Added Services

VALUE ADDED SERVICES

investment in R&D and Engineering, ZEUS has developed automated flaring lines and special tooling that allows us unsurpassed flaring and flanging capabilities.

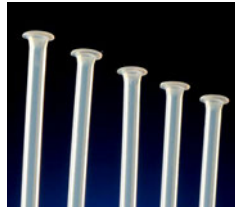

Experience, equipment, and capacity are the reason many of our customers have chosen to outsource their secondary operations to ZEUS. Additionally, ZEUS has developed a wide range of tooling parts required to produce many common flare angles and sizes reducing your lead times and costs.

## Heat Sealing

In applications such as fluid storage, the ends of a polymer tube often need to be sealed closed. Similar to the process used to seal the end of a toothpaste tube, ZEUS can thermoplastically weld closed the end of thin wall lay-flat tubing.

The end of thicker walled tubing can also be heat sealed together in a process known as tipping.

## Heat Shrinking over Mandrels

Our experience at manufacturing precision fluoropolymer heat shrink affords us the unique ability to perform efficient heat shrinking over customer-

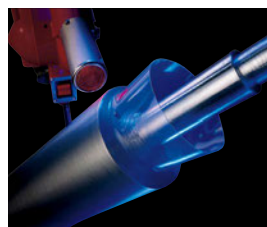

supplied mandrels. Rather than developing a manufacturing process to achieve the ideal balance of oven time and temperature many customers have chosen to have ZEUS perform these operations for them. Our heat shrinking processes and equipment allow us to quickly and efficiently shrink tubing over our customer's parts reducing their equipment and labor costs while decreasing their development costs and production time.

## Product Analysis & Enhancement

At ZEUS we're committed to helping make our products work in your application. Our customers are continually challenging us to push the properties and tolerances of our products further. To support this challenge ZEUS has assembled an exceptional team of engineers, technicians and polymer experts.



These experts have successfully customized a wide range of polymers for industry applications ranging from cutting-edge medical devices to state of the art electronics applications.

Through a scientific process of resin selection, process modification and resin additives, ZEUS can adjust the ways that a polymer will perform in your application. Common modifications range from the



WWW.ZEUSINC.COM

# Value Added Services

VALUE ADDED SERVICES

addition of fillers to improve the radiopacity of a polymer to the addition of carbon for static conductivity.

Advanced modifications might include challenges such as increasing the tensile and mechanical properties of a polymer. These challenges are supported by a team of the most experienced polymer experts in the industry, an advanced analytical lab, and a dedicated R&D facility.

## Product Assembly - High Volume

---

As a world leader in fluoropolymer extrusion, ZEUS is the perfect partner to outsource your high-volume parts assembly. Top manufacturers in industries such as automotive and medical devices trust ZEUS to supply them with high volume tubing based subcomponents.

In addition to world-class extrusion capability, ZEUS has developed world-class machining and fabrication capabilities housed in a dedicated facility. Combined with our experienced engineering department ZEUS has successfully automated time consuming parts assembly.

Our capabilities allow us to reduce your overall costs and help speed your product to market. ZEUS has been delivering pre-packaged sub-components to leading manufacturers and is in an ideal position to offer these services to you.

## Product Assembly - Light

---

Our tubing is used in many advanced products ranging from minimally invasive medical devices to high-performance audio cables and automotive sub-components.

As experts in the manufacturing and modification of the tubular products we offer, many companies have turned to ZEUS to supply various tubing-based sub-components. ZEUS has met this request with our light-product assembly value added services.

## Retractable Coil Tubing

---

ZEUS is pleased to offer a wide range of custom fluoropolymer coiled tubing. Resins such as FEP and PFA. These plastics are known for their excellent chemical resistance, non-stick surfaces, as well as a number of other high-performance properties.

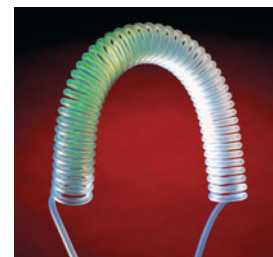

Through a proprietary manufacturing process, ZEUS "heat sets" fluoropolymer tubing into a helical coil that allow for a high degree of flexibility and retractability. This heat setting process fuses the tubing into the helical formation and allows the material to stretch and retract to its programmed position. Custom sizes, coils, and colors can all be manufactured to meet the requirements of your application.



WWW.ZEUSINC.COM

# Value Added Services

VALUE ADDED SERVICES

## Scoring

- Partial slit of a tube's wall running axially along the length
- Facilitates removal of tubing from a device
- Facilitates removal of tubing when used as a manufacturing tool

## Slitting

(Longitudinal cut that goes through the entire wall of the tube along its axial length)

- Allows a tube to be slipped over other components and easily removed (easily installed)
- Spiral slitting also available

## Striping

(Straight and spiraled axial stripes along the length of a tube)

- Radio opaque stripes available
- Helps identify a tube in a bundle
- Custom widths available
- Able to match custom colors

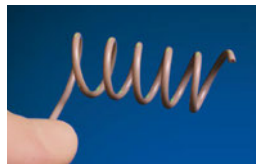

## Thermosetting/Forming

- Use heat to set a tube into a certain shape

## Tube Tipping

Tipping the end of a plastic tube is one of the secondary services we perform for our customers. Tipping involves forming a radius or chamfering the end of the tube to facilitate the assembly of parts.

Through an extensive investment in our secondary services and capabilities, ZEUS engineers have developed a broad portfolio of tipping capabilities. Thermoforming technology can be used to radius the tip in a variety of customer-specified designs. Specialty grinding can be used in applications where thermoforming may not be an option.

From pronounced tips to a slight easing of the tube's edges ZEUS can perform a range of tipping operations. Over the years we have explored a broad portfolio of tipping configurations ranging from decreasing the ID of the tube as the tip profile changes to a complete closure of the end of the tube at the tip.

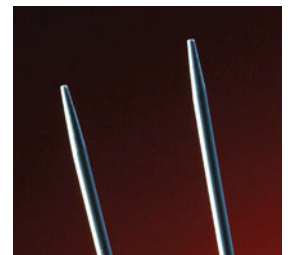





WWW.ZEUSINC.COM

# Value Added Services

VALUE ADDED SERVICES



## PTFE Slitting and Cuffing

Longitudinal slit convoluted tubing as well as cuffed PTFE convoluted tubing are available upon request. Slitting convoluted tubing allows pre-existing wires to be conveniently slipped into the tubing. Cuffing of ZEUS PTFE convoluted tubing provides the ideal smooth surface to attach mechanical connectors and fittings.

### Capabilities include:

- Cuff one or both ends of tubing
- Cuff to specific custom lengths





# ZEUS<sup>®</sup>

TECHNICAL INFORMATION



## TECHNICAL INFORMATION





WWW.ZEUSINC.COM

# Technical Information

## Table of Contents

TECHNICAL INFORMATION

<b>Resin Properties . . . . .</b>	<b>62</b>	<b>Technical Notes . . . . .</b>	<b>74</b>
PTFE - Polytetrafluoroethylene . . . . .	62	Tubing Bend Radius . . . . .	74
FEP - Fluorinated ethylene propylene . . . . .	63	Biocompatibility at Zeus . . . . .	74
PFA/MFA - Perfluoroalkoxy . . . . .	64	Burst Pressure . . . . .	75
PVDF - Polyvinylidene fluoride . . . . .	65	Chemical Compatibility . . . . .	75
ETFE - Ethylenetetrafluoroethylene . . . . .	67	Concentricity Formula . . . . .	75
PEEK - Polyether ether ketone . . . . .	68	Etching - Technical Questions . . . . .	76
Nylons . . . . .	69	Fillers Used in Fluoropolymer Tubing . . . . .	77
PE - Polyethylene . . . . .	70	Glass . . . . .	77
		Bismuth and Tungsten . . . . .	77
		Barium . . . . .	77
<b>General Information . . . . .</b>	<b>71</b>	Low Temperature Rating . . . . .	78
Coloring Plastics . . . . .	71	Lubricity . . . . .	78
Shelf Life and Storage Requirements . . . . .	72	Permeability . . . . .	78
Test Reports/Services . . . . .	72	Sterilization Methods . . . . .	79
Traceability . . . . .	72	UV Compatibility . . . . .	79
Visual Appearance . . . . .	73		



WWW.ZEUSINC.COM

# Resin Properties

## PTFE - Polytetrafluoroethylene

TECHNICAL INFORMATION

### Background

- Originally discovered in the 1930's by DuPont scientist Dr. Roy Plunkett, PTFE was first used in the top secret Manhattan project during WWII. DuPont commercialized PTFE under the tradename Teflon in the late 1940's. Extrudable grades of PTFE were commercialized later and in 1966 ZEUS was founded and began development of advanced manufacturing processes for PTFE.

- As a recognized foundational pioneer of the PTFE tubing market, ZEUS has developed a high performance manufacturing process that allows us to produce a broad range of products for a sizable array of markets and applications

- The unique properties of PTFE has made it the polymer for first choice for many advanced applications. With the lowest coefficient of friction of any polymer and an extremely broad working temperature range, PTFE has been designed into products from advanced medical devices to high temperature industrial equipment. Because of its unparalleled chemical resistance inertness, PTFE has become a choice plastic for the chemical and analytical sciences industries.

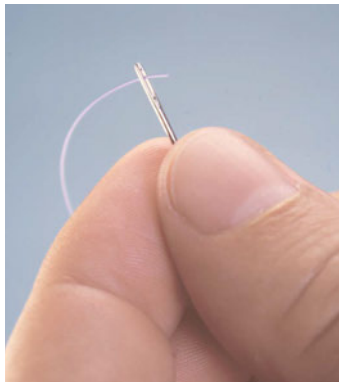

### Key Properties

- Lowest coefficient of friction of any polymer
- Chemical resistance (all common solvents, acids and bases) and inertness
- ETO and autoclave sterilizability
- Working temperature range -454°F (-270°C) to 500°F (260°C)



### Additional Properties

- Excellent dielectric insulating properties
- Class VI approved resins available
- Flame rating - UL 94 VO
- Limiting oxygen index- greater than 95

### ZEUS Capabilities

- Etching capability for bonding
- Fillers available for material modification
  - Radio opaque
  - Carbon
  - Pigments
  - Glass
- Ultra-tight tolerance extrusions
- Extruded forms
  - Tubing
  - Special Profiles
  - Heat shrink
  - Monofilament
  - Multi-lumen





WWW.ZEUSINC.COM

# Resin Properties

## FEP - Fluorinated ethylene propylene

TECHNICAL INFORMATION

### Background

- The development of PTFE was a significant breakthrough in polymer sciences. The special processing requirements of PTFE led researchers to develop a melt-processable version of PTFE resulting in FEP. This new resin was compatible with existing processing methods and equipment. Melt processability also allowed for long continuous extrusions of FEP in applications such as wire and cable.



### Key Properties

- Excellent coefficient of friction
- Chemically resistant and inertness
- Gamma, ETO and autoclave sterilizable
- Maximum working temperature 400°F (204°C)
- Excellent transmission of UV rays
- Lower gas and vapor permeability than PTFE
- Low absorption of solvents (less than 1%)

### Additional Properties

- Radiation resistance
- Excellent dielectric insulating properties
- Melt weldability and thermoformability
- Class VI approved resins available
- Environmental stability
- Flame rating- UL 94 VO
- Limiting oxygen index- greater than 95

### ZEUS Capabilities

- Etching available for bonding
- Fillers available for material modification
  - Radio opaque
  - Carbon
  - UV inhibitors
  - Pigments
- Tight tolerance extrusions
- Extruded forms
  - Tubing
    - Lay-flat tubing
    - Special profiles
    - Heat shrink
  - Monofilament
  - Multi-lumen







WWW.ZEUSINC.COM

# Resin Properties

## PFA/MFA - Perfluoroalkoxy

TECHNICAL INFORMATION

### Background

- PFA was developed to increase the continuous service temperature of FEP resin. Melt processability allows PFA to be processed in longer continuous lengths than PTFE.

### Key Properties

- Excellent coefficient of friction
- Chemical resistance to all common solvents and chemical inertness
- Gamma, ETO, e-beam and autoclave sterilizability
- Maximum working temperature 500°F (260°C)
- Low gas permeability
- Maintains mechanical temperatures
- Available in high purity grades
- Excellent clarity and flexibility
- Combines attributes of PTFE and FEP

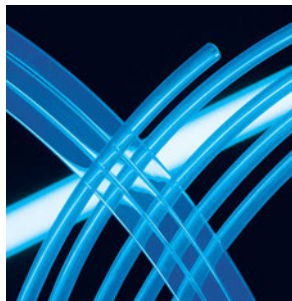

### Additional Properties

- Melt weldability and thermoformability
- Flame rating- UL 94 VO
- Ultra-low levels of ionic extractables

### ZEUS Capabilities

- Etching capability for bonding
- Fillers available for material modification
  - Radio opaque
  - Carbon
  - Pigments
- Tight tolerance extrusions
- Extruded forms
  - Tubing
  - Lay-flat tubing
  - Special profiles
  - Heat shrink
  - Monofilament
  - Multi-lumen





WWW.ZEUSINC.COM

# Resin Properties

## PVDF - Polyvinylidene fluoride

TECHNICAL INFORMATION

### Background

- PVDF was designed primarily for application requiring excellent chemical resistance, high levels of purity and superior mechanical properties. PVDF is often used as a lining or protective barrier in chemical applications.



### Additional Properties

- Radiation resistance
- High dielectric strength over a wide temperature range
- Melt weldability and thermoformability
- Class VI approved resins available
- Environmental stability
- Flame rating- UL 94 VO
- Limiting oxygen index- greater than 95

### Key Properties

- Good coefficient of friction
- Chemical resistance (all common solvents, acids and bases) and inertness
- Gamma, ETO, e-beam and autoclave sterilizability
- Maximum service temperature 130° C
- Excellent resistance to creep and fatigue
- Superior tensile properties and impact strengths
- Excellent mechanical properties over a broad temperature range
- Excellent resistance to cut-through

### ZEUS Capabilities

- Etching capability for bonding
- Fillers available for material modification
  - Radio opaque
  - Carbon
  - Pigments
- Tight tolerance extrusions
- Extruded forms
  - Tubing
  - Lay-flat tubing
  - Monofilament
  - Multi-lumen



Page Intentionally Left Blank



WWW.ZEUSINC.COM

# Resin Properties

## ETFE - Ethylenetetrafluoroethylene

TECHNICAL INFORMATION

### Background

- ETFE is used in applications requiring excellent impact resistance and good resistance to stress cracking. The resin maintains these properties up to its continuous working temperature of 300°F (149°C). ETFE is the resin of choice for applications requiring a fluoropolymer with superior mechanical properties.

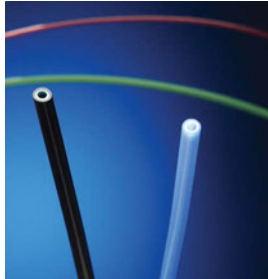

### Key Properties

- Chemical resistance and inertness
- Gamma, ETO, e-beam and autoclave sterilizability
- Excellent impact resistance
- Increased durability and stiffness over other fluoropolymers
- Higher pressure rating than other fluoropolymers
- Higher tensile strength and creep resistance than other fluoropolymers
- Greater crush resistance than other fluoropolymers

### Additional Properties

- Radiation resistance
- Melt weldability and thermoformability
- Flame rating- UL 94 VO
- Limiting oxygen index- 30

### ZEUS Capabilities

- Etching capability for bonding
- Fillers available for material modification
  - Radio opaque
  - Carbon
  - Pigments
- Tight tolerance extrusions
- Extruded forms
  - Tubing
  - Lay-flat tubing
  - Special profiles
  - Monofilament
  - Multi-lumen







WWW.ZEUSINC.COM

# Resin Properties

## PEEK - Polyetheretherketone

TECHNICAL INFORMATION

### Background

- PEEK is a high performance engineered polymer with amazing strength and heat resistant properties. PEEK has become a popular replacement for metal in applications such as aerospace where weight is a primary concern. It has also become the gold standard for HPLC analytical science applications due to its purity, high burst pressure, and chemical resistance. In some medical applications PEEK's chemical resistance, high tensile strength, and lubricity have made it an ideal replacement for stainless steel. PEEK is a very rigid plastic with excellent lubricity and is tan in its natural color.

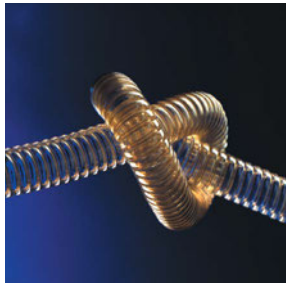

### Key Properties

- Good coefficient of friction
- Gamma and autoclave sterilizability
- Chemical resistance (all common solvents, acids and bases)
- Maximum service temperature 250 - 260° C
- Excellent impact and wear resistance
- Excellent creep and fatigue resistance
- Idea replacement for stainless steel for weight and chemical compatibility

### Additional Properties

- Radiation resistance
- High temperature resistance
- Low flammability value
- Excellent hydrolysis resistance
- High strength
- Thermoformability
- Exceptional torsional stability
- High strength
- High burst pressure

### ZEUS Capabilities

- Fillers available for material modification
  - Radio opaque
  - Carbon
  - Pigments
- Tight tolerance extrusions
- Extruded forms
  - Tubing
  - Lay-flat tubing
  - Special profiles
  - Heat shrink
  - Monofilament
  - Multi-lumen
  - Analytical tubing
  - Sub-Lite-Wall™ tubing





# Resin Properties

## Nylons

TECHNICAL INFORMATION

Since its development in 1935, Nylon has found a home in applications ranging from automotive and aerospace to life saving medical devices and equipment. Nylon is available in a wide range of grades suited for many custom applications. ZEUS extrudes Nylon tubing and lay-flat tubing and can assist in the selection of the specific grade of Nylon best suited for your application.

### Nylon 6

---

- High elasticity
- High tensile strength
- High resistance to abrasion
- High chemical resistance

### Nylon 6/6

---

- Strongest unreinforced aliphatic nylon
- Most abrasion resistant unreinforced aliphatic nylon
- Better low temperature toughness than Nylon 6 or acetal
- Improved stiffness with addition of glass fiber- unlike acetal
- Good fatigue resistance



### Nylon 11

---

- Low water absorption
- UV resistant
- Good tensile strength
- Heat resistant
- Low impact strength

### Nylon 12

---

- Lowest moisture absorption of any commercial nylon
- Chemical resistance
- Excellent dimensional stability and electrical properties
- Low density
- FDA approved



### PEBA

---

- Available in 35-72 and custom durometers
- Good low temperature properties
- Wide range of flex moduli
- Excellent resistance to fatigue during flexing
- Very good tensile strength
- Material modification:
  - Radio opaque



WWW.ZEUSINC.COM

# Resin Properties

## PE - Polyethylene

TECHNICAL INFORMATION

### HDPE

- Maximum temperature: 150° F (66°C) - short duration; 130° F (54°C) - long duration
- Inherent lubricity
- Excellent chemical resistance
- Hardest and stiffest version of PE
- Resistant to sunlight
- Tensile strength: 3,200 - 4,500 psi

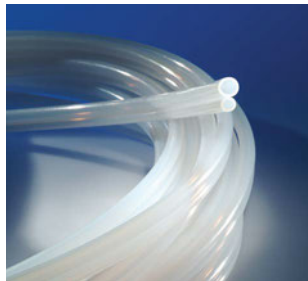

### ZEUS Capabilities

- Extruded forms
  - Tubing
  - Dual Tube™
  - Lay-flat tubing
  - Special profiles



### LDPE

- Maximum temperature: 150°F (66°C) - short duration; 130° F (54°C) - long duration
- Inherent lubricity
- Excellent chemical resistance
- Softest and most flexible version of PE
- High elongation, thus, excellent impact strength
- Tensile strength: 1,200 - 4,000 psi



WWW.ZEUSINC.COM

# General Information

TECHNICAL INFORMATION

## Coloring Plastics

### Introduction to Coloring Plastics

Color measurement and matching may seem to be simple topics, but they represent some of the greatest challenges and difficulties in the plastics processing industry. Understanding color is more than just picking a Pantone® shade. Getting the appearance of the product or component right is fundamental to getting the product right – it is the first thing a customer sees, and mistakes or errors can result in costly rejects.

Color is not just visually important. Due to increasing legislation, particularly in the area of heavy metal colorants, the replacement of many traditional colorants with alternatives that have different performance characteristics and processing are being created (see our RoHS and WEEE information). Color not only affects our emotional response to a product, it is an emotional subject in its own right.

### Standard colors

Standard colors are produced to a Pantone® chart color range. ZEUS can also produce custom colors from tubing samples or other subcomponents to meet your unique specification. ZEUS will work closely with you to match colors to a Pantone® range.

If matching a Pantone® chart color is critical in your application, ZEUS recommends that you have a physical Pantone® chart available on-hand for accurate color results. Pantone® chart colors do not reproduce accurately through the process of digital reproduction and we do not recommend this approach.

ZEUS uses charts from Pantone, Inc. We use the most current Formula Guide, Solid Uncoated, and Pastel Formula Guide + Chips.

Please note that there may be some color variation due to pigment changes from lot to lot. ZEUS will minimize this variance to best effort. ZEUS has also developed the technology to extrude tubing with an integrated straight or spiral stripe of a contrasting color.

### ZEUS Capabilities

- Pantone® chart color matching (please have your own Pantone® chart available for color verification)
- Custom colors from tubing samples
- Striping - Straight or Spiral
- OD-only Striping
- Natural colors available
- Translucent available in some materials
- RoHS and WEEE compliant colors available





# General Information

TECHNICAL INFORMATION

## Shelf Life and Storage Requirements

---

### Extruded Tubing

Fluoropolymer tubing does not have a determined shelf life. Extensive weathering and aging tests have been conducted and they revealed little to no degradation when exposed to weather, U.V. light, or extreme temperatures. Fluoropolymer tubing contains no antioxidant, plasticizers, U.V. blockers, antistatic agents or other additives which would bleed out during normal storage.

### Heat Shrink

FEP and PTFE Heat Shrink tubing conforming to AS23053/11 and /12 are labeled with expiration date on tubing. All ZEUS products are labeled with date of manufacture.

## Test Reports/Services

---

ZEUS' quality is the standard that other manufacturers aim for. Our quality control procedures surpass the industry standards in both the quality of the product and quality and detail of the documentation. ZEUS tubing runs through laser micrometers, making statistical process control data available upon request. Some of the state-of-the-art test equipment available through ZEUS testing labs include:

- Scanning Electron Microscope (SEM)
- Contact Angle Testers
- Laser Micrometers
- Dielectric Tester

- Optical Comparator
- Instron® Tensile Tester
- Differential Scanning Calorimeter
- Melt Flow Index Tester
- Specific Gravity Tester
- Vacuum/Pressure Tester
- Other Specialized and Proprietary Testers

A Certificate of Compliance is sent with every shipment, and test reports certifying conformance to military and commercial specifications are available upon request. Etched tubing is shipped with a certificate of etch, assuring you that the tubing has met ZEUS' rigorous quality standards. Additionally, ZEUS can offer customized testing and certification for the most challenging applications.

## Traceability

---

We at ZEUS take great pride in our ability to maintain full traceability on all parts that we manufacture. Complete traceability is ensured through our ERP system. We can track equipment, inspectors, date of shipment as well as the resin lot that the material was produced from. Through our unsurpassed quality control, we have the ability to trace each lot to its origins as well as supply all test data from each individual lot. ZEUS lot numbers appear on all packaging and shipping containers.



WWW.ZEUSINC.COM

# General Information

TECHNICAL INFORMATION

## Visual Appearance

ZEUS specializes in manufacturing tubing from a variety of fluoropolymer resins for numerous applications. The finished tubing from these different resins can be visually similar, especially if the tubing has had pigment added to it.

The following describes several aspects of the visual appearance of ZEUS tubing that may be helpful in choosing and working with the finished products.

Most fluoropolymer tubing, whether it be PTFE (Polytetrafluoroethylene), FEP (Fluorinated ethylene propylene), PFA (Perfluoroalkoxy), ETFE (Ethylene tetrafluoroethylene), or one of the many other resins ZEUS extrudes, appears a clear to milky white color in its natural, unpigmented state. The clearest fluoropolymer resin is FEP, which allows for a high level of light transmission. PFA is quite clear as well, while PTFE material tends to be more milky in color. Levels of clarity can be modified to some extent through different processing methods and the use of a variety of grades of resin at ZEUS.



Pigmented tubing is available in virtually any color you desire. From the brightest fluorescent yellows, pinks and oranges to the most opaque blues and blacks, ZEUS offers the widest range of colors available in fluoropolymer tubing. Levels of translucency and transparency can be modified to meet your specifications, and samples of many colors are available for inspection at no charge. ZEUS can even match a specific color currently at use in your product

line through the use of color swatches. We also manufacture pigmented tubing to specific colors on the Munsell® and Pantone® color charts.

ZEUS inspection procedures insure all tubing meets the stringent quality standards our customers require. Medical Grade Inspection is available for all products ZEUS manufactures, whether or not a medical application is the end use. We constantly inspect for any particulate matter that may limit performance in your application. Our ISO Class 7 certified clean room assures you of the utmost attention to your purity needs. ZEUS exceeds the highest cleanliness standards set forth in the most demanding industries and applications. You can be assured of the purest, highest quality tubing available when using ZEUS tubing.



All ZEUS tubing is inline visually inspected 100 percent by our highly trained inspection personnel, as well as by our exclusive array of dual axis Zumbach laser micrometers. We are constantly inspecting for any particulate matter that may limit performance in your application. ZEUS routinely limits particulate matter to less than .020", and we strive to supply the cleanest tubing available for the most stringent requirements possible. As a pioneer in fluoropolymer extrusion technology, ZEUS provides virtually flawless products unrivaled in the industry.



WWW.ZEUSINC.COM

# Technical Notes

TECHNICAL INFORMATION

## Tubing Bend Radius

The question is often raised as to what is the minimum bend radius of a specific size of tubing. The bend radius is established primarily by three different factors: diameter, wall thickness, and resin. ZEUS prides itself in its sample program through which we work with companies to find the right material and perfect size.

As a general guide, however, we have performed a series of bend tests that we hope will guide you in determining the size that is most suitable for you.

The following is a guide to the bend radius of our PTFE Industrial Wall tubing: Based on a minimum of 36" lengths:

Size	Diameter*
1/32" Industrial	.660"
1/16" Industrial	1.375"
3/32" Industrial	2.00"
1/8" Industrial	3.25"
3/16" Industrial	4.00"
1/4" Industrial	6.50"
5/16" Industrial	8.00"
3/8" Industrial	9.00"
7/16" Industrial	9.50"
1" Industrial	12.00"

\*Please Note: The bend radius is 1/2 the diameter.

Contact your Zeus team to learn more about our resins that are USP Class VI tested by independent laboratories. These resins are then used to manufacture a wide range of products that are used as components in medical devices, diagnostic, and analytical applications.

In conjunction with USP Class VI tested resin, we also have USP Class IV testing completed for pigments and compounds.

**Zeus certifies that select resins and pigments meet the following USP Class VI requirements:**

- Systemic Injection  
(Acute Systemic Toxicity, Mice)
- Intracutaneous Test (Intracutaneous Toxicity, Rabbits)
- Implantation Test (Implant, Rabbits)

In addition to the extensive testing that we do on vendor resins, we offer 100% traceability on all your orders.

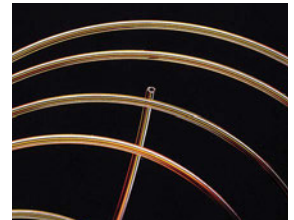

## Biocompatibility at Zeus

Zeus is proud to offer USP Class VI approval certifications in response to the unique requirements of the Medical Device Manufacturing community.



WWW.ZEUSINC.COM

# Technical Notes

TECHNICAL INFORMATION

## Burst Pressure

ZEUS has been supplying fluoropolymer tubing to manufacturers of high pressure devices since our inception. The innate strength of all fluoropolymers make their use in these kinds of applications an ideal choice. Below, you will find a formula for calculating the maximum burst pressure by using Tensile Strength Values.

The theoretical burst pressure of tubing at ambient temperature can be calculated by using the ID and OD dimensions in inches and the tensile strength at yield in pounds per square inch.

The following formula is to be used as a guide in the design process. It does not consider factors such as steam pressure and elevated temperature, altitude, etc., and it is calculated at ambient room temperature. The burst pressure result is meant as a guideline in design, not a definitive number.

$$P = \frac{T(OD^2 - ID^2)}{OD^2 + ID^2} \quad \begin{array}{l} P = \text{Theoretical Burst Pressure, psi} \\ T = \text{Tensile Strength at Yield, psi} \end{array}$$

## Chemical Compatibility

Fluoropolymer resins are essentially chemically inert. This has long been one of the greatest assets of these plastics. Fluoropolymers are an ideal transport medium for today's highly volatile chemical compounds and exotic fluids. The widespread acceptance within the chemical, environmental, defense, aerospace, and medical industries is a testament to fluoropolymers' unique ability to withstand and resist a wide variety of liquid and gaseous compounds.

There are very few chemicals, such as molten alkali metals, turbulent liquid or gaseous fluorine, chlorine trifluoride, or oxygen difluoride, that are known to react with fluoropolymers.

To a lesser degree, halogenated organic chemicals may be absorbed by fluoropolymer resins. This will cause a very slight change in weight or possibly a slight swelling. This phenomenon is less evident in FEP and PFA extrusions because they are relatively less permeable than PTFE extrusions.

## Concentricity Formula

To determine a tube's concentricity use the following formula:

W min is the minimum wall thickness and W max is the maximum wall thickness of the sleeve as taken from any location of the wall of a tubing's cross section. This can be measured using a toolmakers micrometer or optical comparator.

- ASTM D 2671 11.3

$$C = 100 \times \frac{(W \text{ min})}{(W \text{ max})}$$





WWW.ZEUSINC.COM

# Technical Notes

TECHNICAL INFORMATION

## Etching - Technical Questions

*Why would I need to etch tubing?*

Fluoropolymers such as PTFE, FEP, and PFA (often called Teflon®) are very lubricious (slippery). This lubricity and the chemical composition of fluoropolymers reduces their bondability. Etching alters the surface properties of the polymer allowing it to be bonded with conventional adhesives.

*How does it work?*

Etching is performed by the chemical reaction between a sodium solution and the fluorine molecules on the surface of the tubing. Fluorine molecules are stripped from the carbon backbone of the fluoropolymer. This leaves the carbon atoms with a deficiency of electrons. When the etched material is exposed to air, oxygen molecules, water vapor, and hydrogen allow restoration of the electrons. This restoration process results in a group of organic molecules responsible for adhesion.



*Will etching change the properties of my tubing?*

The etching process only penetrates to a depth of a few angstroms so the properties of the tubing will remain mostly unaffected. However the etching process will darken the surface of the material, usually to a brown or tan shade. Surface lubricity is also reduced by the etching process.

*How should I store etched tubing?*

Etched fluoropolymers will “grab” molecules from the air to repair their electron

deficiency. This results in a weakening of the surface etching. For this reason, all etched materials should be stored in their original sealed bags. ZEUS ships all etched tubing orders in sealed black protective bags to prevent degradation from UV radiation.

*Does a darker color mean a better etch?*

Color is not a reliable indicator of etch quality. For this reason ZEUS includes etch certifications with each order shipped.

*How is the etch tested?*

The etched material is tested using the contact angle method. Contact angle measurements of liquid droplets on substrate surfaces are used to characterize surface wettability. As shown in Figure 1 below, the contact angle is defined as the angle between the substrate support surface and the tangent line at the point of contact of the liquid droplet with the substrate. In this picture, example “B” demonstrates a more effective etch than example “A” .

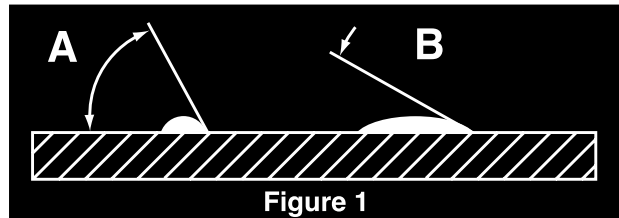

Figure 1

ZEUS performs contact angle tests on all etched tubing orders and includes a Certificate of Compliance with the material.



WWW.ZEUSINC.COM

# Technical Notes

TECHNICAL INFORMATION

*What is the shelf life on etch products?*

Many etched products have an almost unlimited shelf life when stored properly. ZEUS recommends following good inventory practices, rotating stock, and using inventory as soon as possible.

## Fillers Used in Fluoropolymer Tubing

There are a number of reasons why a filler may enhance the performance of ZEUS tubing, such as increased tensile strength, higher resistance, and increased rigidity. The following information may help to choose the filler that best suits your application. Contact a ZEUS Technical Account Manager for more information.

## INDUSTRIAL USES

### Glass

Glass fillers are used to increase abrasion resistance in potentially harsh mechanical applications. Small glass beads are added to the resin and are blended in during the extrusion process. The finished tubing is extremely strong and resistant to the many sources of wear fluoropolymer tubing may be subjected to in an industrial application. Glass also increases the corrosion resistance at high temperatures. ZEUS has also developed a special technology to produce glass-filled PTFE with a smooth surface finish.

## MEDICAL USES

### Bismuth and Tungsten

Bismuth is used to allow PTFE, Pebax®, and other tubing to be visualized on a fluoroscopic screen during invasive procedures. This allows the physicians to see the surgical implantable device both during and after the procedure has been completed. Visualizing the device allows the physician to guide and maneuver the device for proper placement or alignment. Bismuth will also allow the device to be visualized on routine diagnostic radiographs. Bismuth is well accepted in the medical profession to be in contact with the body.

### Barium

Barium is used in FEP and other tubing as bismuth is used in PTFE tubing above. Surgical or implantable devices can be viewed on fluoroscopic screens during and after surgeries and on diagnostic radiographs. And, as bismuth, it is medically accepted for contact with the body.





WWW.ZEUSINC.COM

# Technical Notes

TECHNICAL INFORMATION

## Low Temperature Rating

---

Fluoropolymer resins maintain their lubricity, abrasion resistance, and strength at temperatures below freezing. Extensive testing at 0°F (-18°C) and lower have shown that PTFE is the ideal choice for cryogenic applications. With a low temperature range of -450°F (-268°C), showing little or no embrittlement, PTFE remains highly flexible at temperatures below -100°F (-73°C).

## Lubricity (*Coefficient of Friction*)

---

Lubricity is defined in the Webster's New World Dictionary as "slipperiness; smoothness". It is more widely known in our industry as the coefficient of friction. Lubricity is one of many unique characteristics of fluoropolymers that separates itself from other polymers. The fluoropolymers have a smooth surface with a slippery feel.

Because of the low coefficient of friction, there have been many practical non-lubricated and minimally-lubricated mechanical systems developed around fluoropolymers. The low coefficient of friction is a result of low interfacial forces between its surface and other materials and the comparatively low force of deform.

Fluoropolymer's low coefficient of friction properties are tremendous advantages in increasing flow rates, reducing friction in critical applications, and allow the materials to be cleaned easily. In fact, PTFE has a coefficient of friction that is, amazingly enough, comparable to ice on ice, and it even remains stable under severe load.

## Permeability

---

### Definition:

1. The flux of a small penetrate molecule (permeate) through a matrix which accounts for chemical interaction between the permeate and the matrix.
2. The property of a material quantization the flux of a small penetrate molecules (permeate) through a material such as a polymer by a sufficient chemical and concentration gradient.
3. The product of the Diffusion (interaction-less transport of a small diffusion molecule through a matrix based on a concentration gradient) and the Solubility (the interaction between the solubility diffusion and the matrix).
4. To get a true test of permeation, the test should be run on the final component, due to the impact of morphology of the polymer matrix and the many variables that can impact permeability.

### Water Absorption

Water absorption in polymers can be effected by the polymer selected, fillers used, and processing method. A range of typical water absorption properties can be reviewed in our summary of properties sheet at the end of this catalog. If water absorption is a key concern please contact a ZEUS Technical Account Manager for advice in selecting the ideal resin for your application.



WWW.ZEUSINC.COM

# Technical Notes

TECHNICAL INFORMATION

Relationship for gaseous permeation is:

$$P = D S$$

P is the permeability (cm<sup>3</sup>(STP)/sec-cm-cm Hg)

D is the diffusion coefficient (sm<sup>2</sup>/sec)

S is the solubility coefficient (cm<sup>3</sup>(STP)/cm<sup>3</sup>-cm Hg)

## Sterilization Methods

Please see the following table to select the best material suited for your sterilization method of choice.

### Sterilization methods:

#### ETO, Autoclave, and Gamma

Resin	ETO	Autoclave	Gamma
PTFE	Excellent	Average	Poor
FEP	Excellent	Excellent	Good
PFA	Excellent	Excellent	Poor
ETFE	Excellent	Excellent	Good
PVDF	Excellent	Excellent	Good
PEEK™	Excellent	Excellent	Excellent
Polyethylene	Excellent	Good*	Good**

\* Some grades may allow

\*\* High density grades not as stable as medium density and low density grades

## UV Compatibility

ZEUS tubing is virtually unaffected by weather or prolonged exposure to ultraviolet light. Independent testing on samples exposed to virtually all climatic conditions confirm the weather resistant properties of fluoropolymer tubing. Where applications demand complete dependability in these conditions, fluoropolymers are the answer. Resistance to extreme heat, cold, and ultraviolet light encountered in radar and other electronic components, such as antenna bushings, are excellent examples of the value of this material in these applications.

Ultraviolet transmittance can be another useful aspect of fluoropolymer tubing. While levels of UV transmittance vary among the fluoropolymer resin family, ZEUS tubing is used in applications such as water purification with excellent results. Crystallinity and wall thickness also affect the level of transmittance tubing will allow. Contact a ZEUS Technical Account Manager for more information on this very useful property of fluoropolymer tubing.



## Summary Of Properties

The information presented in this publication is believed to be accurate and is not intended to constitute a specification. Property characteristics are dramatically impacted by geometry and processing method; therefore the properties of extruded parts may vary. This table is only meant to serve as a general guideline; users should evaluate the material to determine the suitability for their own particular application.

<b>PHYSICAL</b>	<b>ASTM</b>	<b>PTFE</b>	<b>FEP</b>	<b>PFA</b>	<b>PVDF</b>	<b>EFEP</b>	<b>ETFE</b>	<b>PEEK</b>
Density (g/cc)	D792	2.16 -2.22	2.12-2.17	2.12-2.17	1.76-1.88	1.74	1.7-1.86	1.1-1.48
Water Absorption (%)	D570	0	0.004	<0.03	0.01-0.06	0.1 max	0.007	0.1-0.45
Standard Percent Crystallinity (%)		>90	70	48-70	35-70	10	50	25-35
Refractive Index		1.35	1.33-1.35	1.35	1.42	1.338-1.34	1.34	---
Radiation Resistance (MRad)		1	10	1-10	1000	---	50	1000
Oxygen Index (%)	D2863	>95	95 min	95 min	44-80	31	30-46	35
<b>MECHANICAL</b>	<b>ASTM</b>	<b>PTFE</b>	<b>FEP</b>	<b>PFA</b>	<b>PVDF</b>	<b>EFEP</b>	<b>ETFE</b>	<b>PEEK</b>
Hardness, Shore D	D2240	50-65	55-65	55-60	65-82	75	63-72	>85
Ultimate Tensile Strength (MPa)	D638	20-35	18-34	25-35	17-48	40-50	37-50	75-97
Elongation at Break (%)	D638	200-550	245-400	250-420	50-400	420-460	200-550	96-110
Modulus of Elasticity (GPa)	D638	0.39-0.6	0.44-0.64	0.45	0.5-5	0.490-0.78	0.49-0.78	2.3-4.3
Flexural Modulus (GPa)	D790	0.275-0.7	0.58-0.62	0.6-0.7	1.3-7	0.88-1.37	0.7-1.2	3.6-4.1
Coefficient of Friction		0.02-0.2	0.04-0.2	0.04-0.2	0.14-0.23	0.055-0.078	0.05-0.4	0.34
<b>ELECTRICAL</b>	<b>ASTM</b>	<b>PTFE</b>	<b>FEP</b>	<b>PFA</b>	<b>PVDF</b>	<b>EFEP</b>	<b>ETFE</b>	<b>PEEK</b>
Volume Resistivity ( $\Omega$ -cm)	D257	1e14-1e19	1e17 - 1e18	1e18	1.5-2e14	1e16	1e17	4.9e16
Dielectric Constant 1MHz	D150	2.1	2-2.1	1.9-2.1	7	2.6	2.5-2.6	2.8-2.2
Dielectric Strength (V/mil)	D149	189-610	500-2000	500-2000	800-1700	400	400-1800	500
<b>THERMAL</b>	<b>ASTM</b>	<b>PTFE</b>	<b>FEP</b>	<b>PFA</b>	<b>PVDF</b>	<b>EFEP</b>	<b>ETFE</b>	<b>PEEK</b>
Conductivity (W/m-K)	C117	0.167-0.3	0.19-0.25	0.15-0.25	0.17-0.19	0.24	0.24	0.25
Maximum Service Temp, Air (°C)		260	200-205	260	100-130	150	150	250-260
Minimum Service Temp, Air (°C)		-200-240	-200-240	-200		---	-100-1890	
Melt Temperature (°C)		327-342	265-275	300-315	172	160-195	230-280	343
Glass Temperature (°C)		127	80	100	-30-40	-40-50	40-80	143
Decomposition Temperature (°C)	E1131	400-500	380-430	475	375-400	350	350-380	540
CTE, linear 20° ( $\mu\text{m}/\text{m}\cdot\text{°C}$ )	D696	126-180	100-135	120-140	90-144	50-90	50-90	47



P. O. Box 2167, 3737 Industrial Blvd, Orangeburg, SC 29116-2167, USA  
1-800-526-3842 • 1-803-268-9500 • FAX: 1-803-533-5694 • [www.zeusinc.com](http://www.zeusinc.com)

This is an uncontrolled copy and may not be the most recent version. Please refer to [www.zeusinc.com](http://www.zeusinc.com) or contact Zeus at (800) 526-3842 for our most recent information.

QF7.2-012 Rev. G-V1R14